

USER MANUAL

TRIGLOW GL-2



Download Smart Garden App

Smart Garden App allows you to control and customize your controls for Smart Solar Lamp via your smart device.

Search for the latest version on Apple App store or Google Play.

CONTENTS

02	IMPORTANT SAFETY INSTRUCTIONS
03	GETTING TO KNOW SMART SOLAR LAMP
07	USING YOUR SMART SOLAR LAMP
12	TROUBLESHOOTING

IMPORTANT SAFETY INSTRUCTIONS

Read All Instructions Before Use And Save For Future Reference

This is an electric lamp-not a toy!
To avoid risk of fire, burns, personal injury and electric shock, it should not be played with or placed where small children can reach it.

SAVE THESE INSTRUCTIONS



To ensure correct installation and function, always follow these instructions.



DO NOT dismantle or modify by yourself. Always ask authorized person for repair.



DO NOT install near extreme heat sources, moisture, or corrosive substances.



Avoid contact with sharp objects and strong chemicals.



Any other problems during use, contact our Customer Support for help.

Getting to Know Smart Solar Lamp

In The Box



Solar Panel x 1 Smart Solar Lamp x 3

Solar Panel Spike x 1



Lamp Spike x 3



Short Screw x 3



Wall Plug x 3



Instruction Manual x1



Specifications

Model	TriGlow GL-2
Power Supply	3 x 3.7V 2200mAh Li-Ion Battery
Power	Max. 3W
Input Power	5V 1A
Solar Panel	6V Monocrystalline
Body Material	Stainless Steel + Glass + ABS
IP Grade	IP44
Supported OS	Android 5.0 or iOS 9.0 and above
Bluetooth	4.0 and above
Voice Control	Alexa & Google Assistant (only available when connect to Galaxy link light)

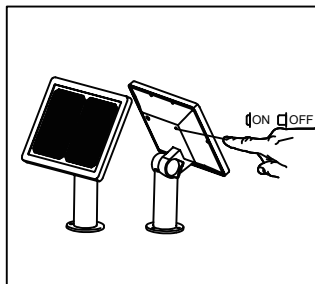
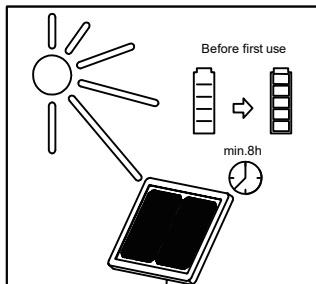
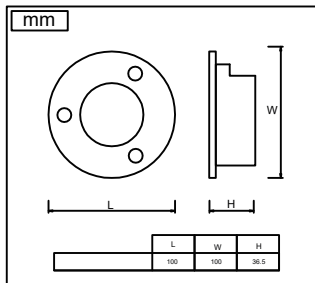
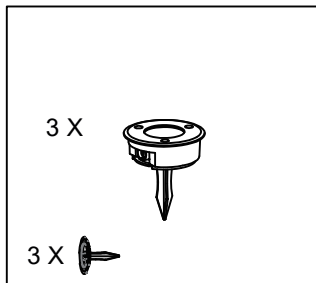
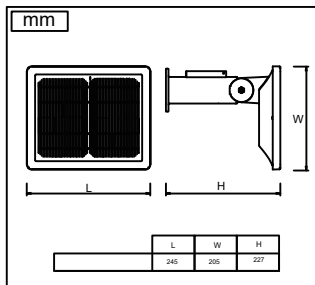
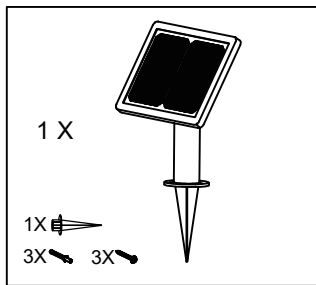

How to Install the Solar Panel

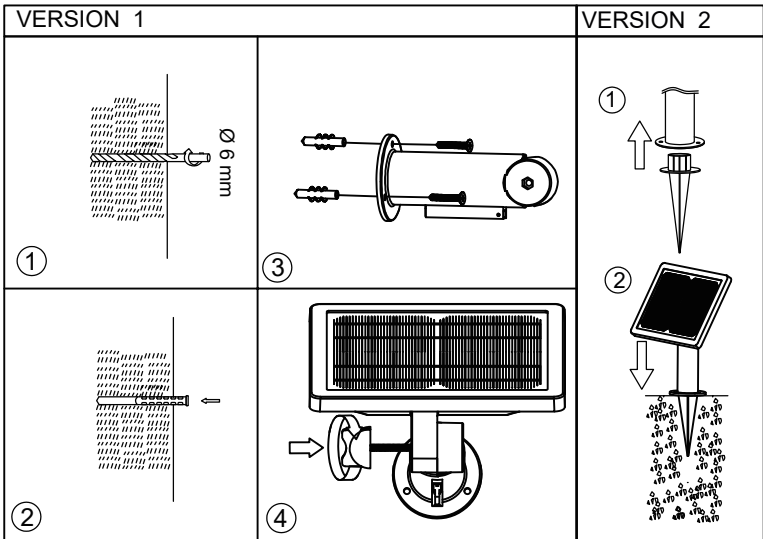

Using Your Smart Solar Lamp

Connecting with Smart Device



1. Download “Smart Garden” from Google Play or Apple App Store and install. Register as instructed

2. Make sure your smart device’s bluetooth, cellular and location have turned on before pairing

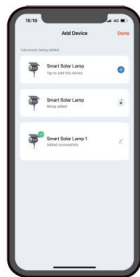
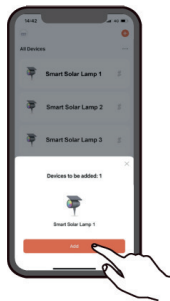
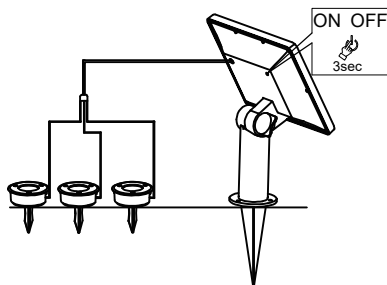

3. Press the Power button to turn on the lamp (if the lamp has been paired with another device before, please reset the lamp, see page 10)

4. Open App, follow the on-screen instructions to add your lamp.

Controlling with APP



Always make sure your smart device's bluetooth have turned on to control the lamp

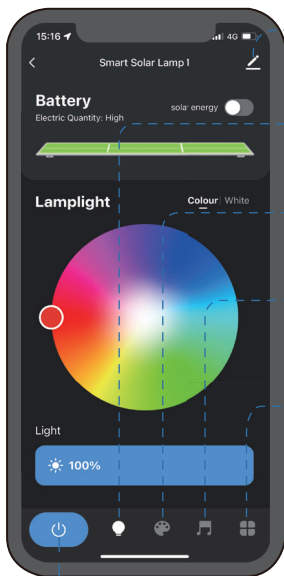

About

Information about the device or other



Static Color Settings

Customize the color or brightness



Dynamic Scene Settings

Select a preset Scene(6 Scene available), edit or add a new scene?



Music Rhythm

Select the rhythm collected by mic of smart device.



Schedule Mode

Schedule for the auto-on/off and solar mode timer.

Low Power Setting

Lower the brightness when battery is low

Quick Linkage

The device needs to be under gateway for the intelligent linkage configuration to take effect.



Power On/Off

Tap to turn ON/OFF the lamp

Using Your Smart Solar Lamp

Controlling without Smart Device

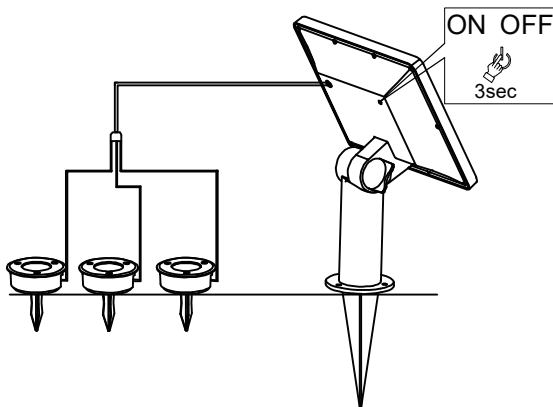

The lamp can also be controlled without Smart device:
Press the power button once to switch mode between:

1. Mode A: Lamp breathe twice, then turn to Photosensitive* mode
2. Mode B: Constant Lighting
3. Turn Off

If lamp has connected to a smart device before, the lamp will automatically use color&brightness setting from last time.

*in Photosensitive mode lamp will turn off if enviroment is bright enough

Switch to a new device/Reset the lamp

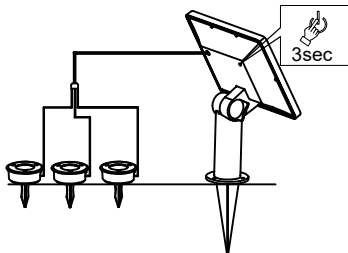

1. Hold power button for 3 seconds, the lamp will flash in blue. Lamp has now been reset and automatically turn into pairing mode.



2. Make sure your new device's bluetooth, cellular and location have turned on

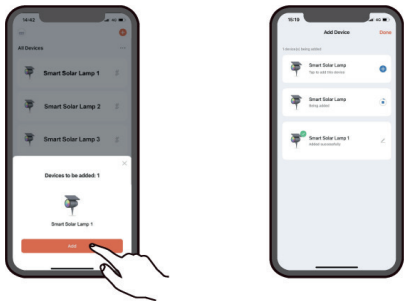

3. Open App on new device, follow the on-screen instructions to add your lamp.

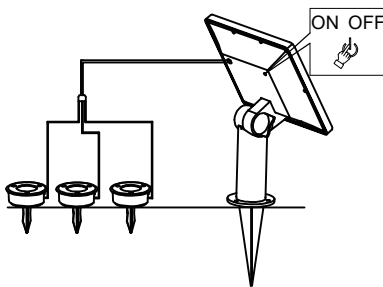

4. If you only want to reset the lamp, can press the power button after 10 seconds to exit blue flashing pairing mode

Using Your Smart Solar Lamp

Create Group with other Lamps

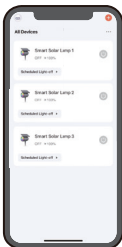

1. Make sure all lamps have connected to your device and controllable before create group



2. Enter any lamp's control panel, touch the 'Pencil' icon on right top side of screen

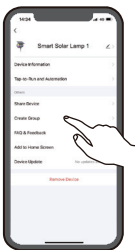

3. Touch 'Create Group' on the menu list

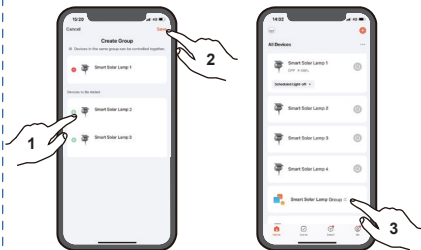

4. Add the lamp you need and touch 'Save' on top right side of screen, then you can see the group in your device list

Troubleshooting

Problem	Reason	Reason
Connecting Failure	Cannot find Smart Lamp on App when adding lamp	Make sure Bluetooth, Cellular and Location have turned on and Smart Garden App is authorized to use above function.
	When lamp is connected and accidentally enter the pairing mode, when connecting with smart device again, the progress is very slow and finally lead to pairing failure.	Remove the previous lamp on App and hold the power button to blue flashing pairing model to connect again function.
Can not turn off the lamp	Cannot exit blue flashing paring mode	Wait 10 seconds then click the button to turn off
Can not turn on the lamp	Lamp is out of power	Charge the lamp, delete the lamp on App to save the power if long time not using the lamp
Can not set the scheduel mode	There may be an error of about 30s in timing	Set the timing time at least 30s
Lamp Flashing During Charging	Current adaptor's charging power is too low, cannot properly charge the lamp	Change to a adaptor with higher power ($\geq 5V$ 1A)

 GB**Instructions:**

This unit contains rechargeable batteries. Switch the ON/OFF switch to “ON”. The unit is ready to be used now. Place the solar panel in a way that it will collect as much daylight as possible (not right under a tree, in the shade). When it starts to get dark, a light/dark sensor will switch the unit on automatically. After 6-8 hours the lights will automatically stop burning. Then the next day, batteries will be recharged again by the daylight. Please note that a sunny, bright day will make the LED’s light up longer and brighter and a dark, cloudy day will make the light shorter and dimmer.

The batteries in this set are replaceable. If you wish to replace the batteries, please acquire at your local garden center or hardware store for rechargeable batteries that match the technical specifications of the battery(ies) used in this lighting set, for safe and proper functioning.

Please note: Prior to first use, the solar light must be charged for 1 or 2 days in direct sunlight, with the switch turned on. This will benefit the lifetime of the battery(ies) and assures proper functioning of the lighting set.

This light-set can be used outdoors.**Please keep all the relevant information for future reference!**

IMPORTER:**B&K LUMITEC**

2 rue Alfred Kastler
Zone Industrielle
67850 Herrlisheim - France

OFFICE FRANCE

+33 (0) 3.88.96.80.90
info@bklumitec.com

OFFICE EXPORT

+49 (0) 7248 94790 30
export@bklumitec.com