

FOG **SMOKE FACTORY** & HAZE

FOG AND HAZE GENERATORS

See the Performance

Instruction Manual



Type: Fire Trainer

FOG **SMOKE FACTORY** & HAZE

FOG AND HAZE GENERATORS

Welcome.
Thank you for choosing a
SMOKE FACTORY - FIRE TRAINER.

The SMOKE FACTORY product range offers you a vast variety of complete solutions, both from an innovative and economical point of view.

On the following pages we will provide you with a general overview of the FIRE TRAINER.

	Page
1 Foreword	2
2 Safety Instructions	3
2.1 Danger of Burning	3
2.2 General Safety	3
3 Device and Parts Identification Guide	4
4 Commissioning	6
4.1 Selecting the Location	6
4.2 Installing and Changing the Fluidbottle	6
4.3 Fogfluid	6
4.4 Power Connection	6
5 Operating Instructions	7
5.1 Controls	7
5.2 Switching the device off	7
5.3 Control System	8
5.3.1 External Control	8
5.3.2 DMX512 Control	8
5.3.3 Stand Alone Control	9
5.3.4 Radio Control (optional)	10
5.3.5 Pin Configuration	10
6 Using the Timer	11
6.1 Autostart	12
7 Maintenance	13
8 Trouble-Shooting	14
9 Technical Specifications	15
10 Warranty Conditions	17
11 Services	18

See the Performance

SMOKE FACTORY

FOG & HAZE GENERATORS

1. Foreword

Well-engineered and innovative.

Fog Generators for more than 20 years.

SMOKE FACTORY GmbH is a medium-sized enterprise with growing international orientation.

Our fog generators are the result of many years of experience and continuous development in the field of stage machinery. The development- and construction-departments cooperate intensely to provide you with future- and practice-oriented solutions. The development-, construction- and production-operations are performed in our factory in Hanover, maintaining a high quality standard.

You acquired a **SMOKE-FACTORY** device that you will use simply and safely. Thank you for placing your trust in us. Read and understand the safety precautions before operating the machine. Failure to properly follow these instructions may lead to a fire, explosion or electrical shock.

Additionally we offer you complete and customised solutions.

Our members of staff are highly qualified. They understand your needs and with their expertise and experience they have an overwhelmingly positive effect on our whole **SMOKE-FACTORY** team.

Please contact us if you wish further information about our fog generators.



Type: Fire Trainer



SMOKE FACTORY

FOG AND HAZE GENERATORS

2. Safety Instructions

Danger!

Follow these instructions to avoid fire, explosions or electrical shocks.



Warning!
Don't endanger yourself. Read the safety instructions thoroughly.

2.1 Danger of Burning

- Warning! Very hot steam escapes from the nozzle. There is a high danger of getting burnt. The smoke machine must be placed at least **150 cm** away from persons and heat-sensitive materials. Assure yourself that the housing of the fog generator cannot be touched by accident.
- The smoke machine must be placed at least **60 cm** away from inflammable materials.
- Occasionally very hot droplets of fluid may escape when in operation. Always keep sufficient safety distance.

2.2 General Safety

- Never open the machine and leave the machine unattended when connected to a power supply.
- Don't use the fog generator close to open fire, pyrotechnics or fireworks!
- The visibility must not be reduced to fewer than 200 cm. You are responsible for accidents due to missing visibility.
- Do not open the smoke machine if it is connected to the power supply (230 V).
- Do not swallow the fog fluid. Keep it away from children. In case of eye contact, rinse with a lot of water. Consult a doctor should you have accidentally swallowed some fluid.
- Spilled fluid or splashed fluid droplets can cause slip hazard. Mop up the fluid and dispose of it according to regulations. SMOKE FACTORY-fluid is completely water-soluble and biodegradable.
- Artificially-made fog can be produced in many different ways. The method used here to produce fog, with a device which works according to the vaporizer principle, is the most harmless one.
- No case has so far been reported in which a sound human being has been harmed because of using our device to produce artificial fog. However, this can only be guaranteed if the professional fog generators are used accordingly, i.e. at the correct vaporization temperatures as well as with the correctly mixed fog fluid.

WARNING!

People with health problems or problems of the respiratory tract or with an inclination for allergies should avoid any contact with artificially-made fog.

Damages that are caused by non-intended use and non-observance of this instruction manual are borne by the user himself. The manufacturer does not assume liability.

Modifications of security-relevant parts are strictly forbidden.

FOG SMOKE FACTORY & HAZE

FOG AND HAZE GENERATORS

3. Device and Parts Identification

Simple and safe.
We offer you complete solutions

There isn't any solution that fulfils all expectations, but for each and every expectation there is a proper **SMOKE FACTORY**-fog generator.

Scotty II or *Fire Trainer*? It doesn't matter.
You get the equipment that makes the difference.



Side View

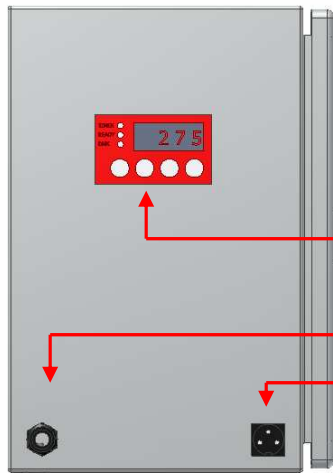

- Control panel for adjusting the DMX start address and the output
- Power Cable
- DMX in/out or analog input (depending on device)

Rear View

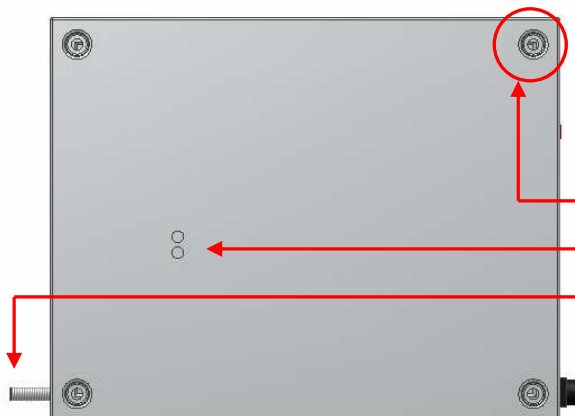

- Two holes for wall fastening
- Two nozzles
- Fluid tube inlet

FOG SMOKE FACTORY & HAZE

FOG AND HAZE GENERATORS

Front view

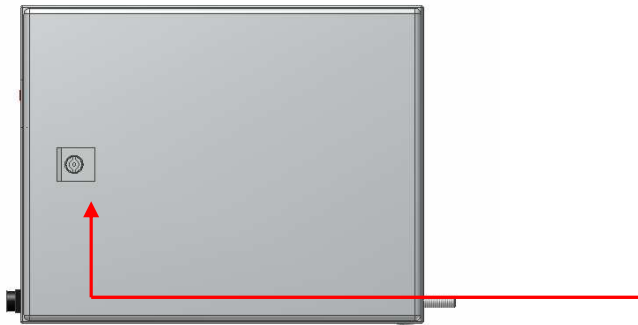

- Opening for interior space
(control unit, heating unit, fluidpumps)

Bottom View

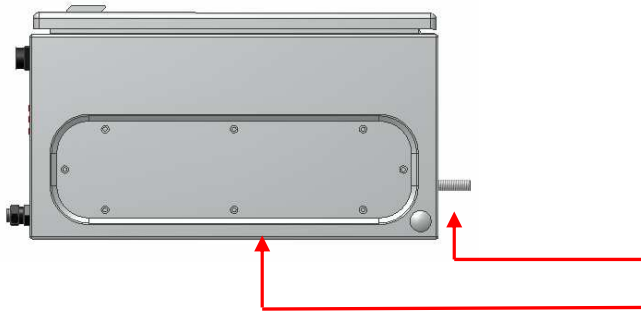

- Drain valve
- Baseplate (Don't remove!)

Connection View

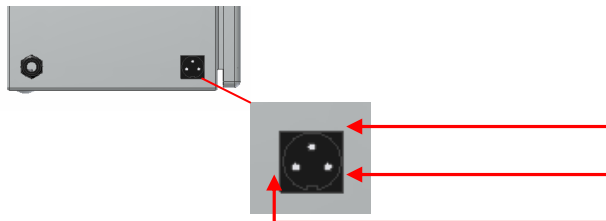

Pin-Configuration

- Pin 3 / top
- Pin 1 / right
- Pin 2 / left

Canisterclosing

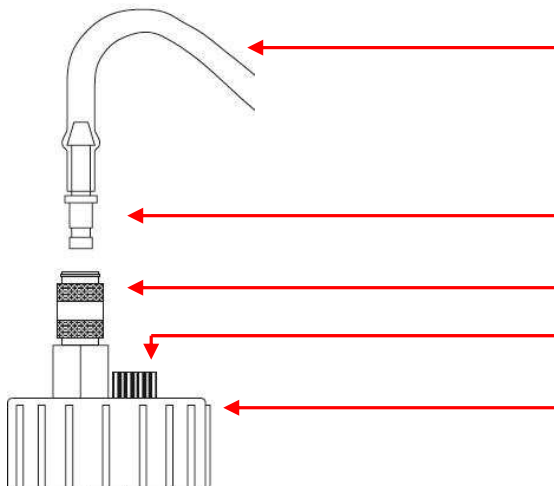

- Fluid tube
- Attachable coupling
- Collar to remove the tube
- Ventilation valve closure
- Canister lid

SMOKE FACTORY

FOG AND HAZE GENERATORS

4. Commissioning

4.1 Selecting the location

The location must be

- free from vibrations,
- a non-flammable place or surrounding,
- well-ventilated with haze-free air
- keeping the ambient operating temperature between -20°C and +70°C and
- a relative humidity below 80%.



4.2 Installing and Changing the Fluidbottle

- Disconnect the fluid tube from the lid by retracting the collar and removing the attachable coupling.
- Unscrew the canister lid of the empty container and screw it onto the new container.
- Push the attachable coupling into the collar, until you hear a click. The collar is now locked firmly.

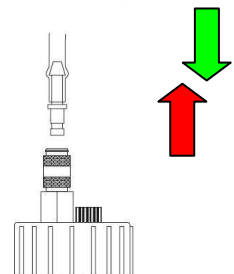

4.3 Fogfluid

To guarantee trouble-free operation the special SMOKE FACTORY fluid must be used.

Use of other liquids will void the manufacturer's warranty.

Don't use fluid older than two years.

You can store it for a very long period.

If you wish more information about fluids, don't hesitate to contact us.

Nebelfluid Sortiment:

- | | |
|------------------|---------------------------------|
| • FAST-FOG | Very fast dissolving fluid |
| • SUPER-FOG | Long durable standard fluid |
| • HEAVY-FOG | Very long durable fluid |
| • DESIGNER-FOG | Long durable haze fluid |
| • HEAVY-FOG PLUS | Special fluid for fire fighters |



Nebelfluid

4.4 Power Connection

Connect the power plug to an electrical outlet (DIN 49440/441).

Make sure the outlet has the correct voltage for your machine. (230V/50Hz).

A „P“ and two figures appear on the LED display (for instance **P 15**)

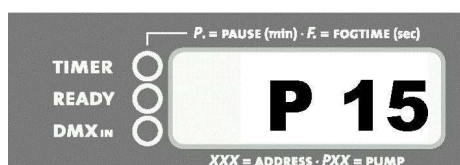

After 7 minutes the FIRE TRAINER is heated up.

As soon as the proper temperature is achieved, the ● green LED will be lit permanently.

FOG SMOKE FACTORY & HAZE

FOG AND HAZE GENERATORS

5. Operating Instructions

The optimal equipment of your SMOKE FACTORY fog generator is based upon your specific application.

The FIRE TRAINER is equipped with 2600 W and two high capacity pumps.

Therefore it is a truly powerful smoke machine.

Due to the digital technique it is possible, to generate tiny clouds as well as roomfilling fog.

The performance of the fog generator can easily be adjusted between 1 and 99%.

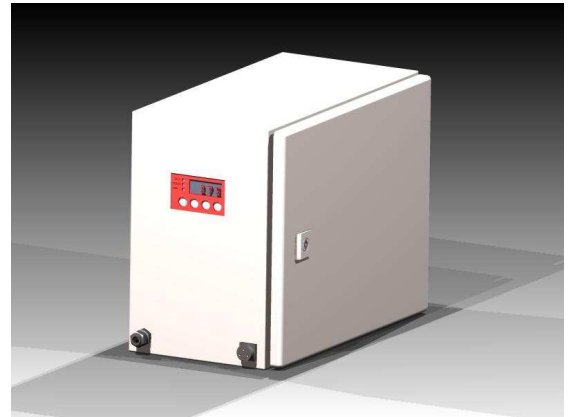

5.1 Controls

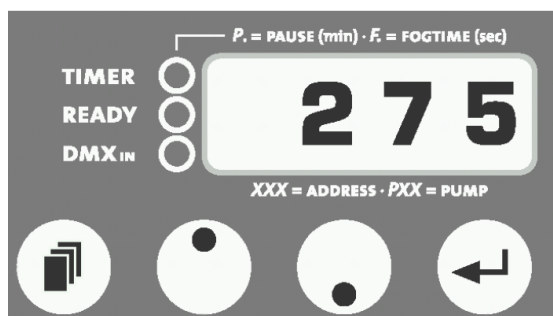

TIMER-LED / Red	●
READY-LED / Green	●
DMX IN-LED / Yellow	●

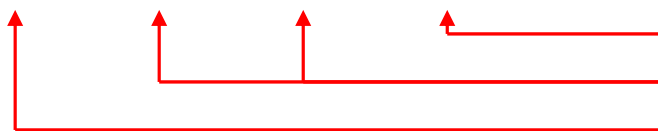

- ENTER-Button
- UP/DOWN-Button
- MODE-Button

5.2 Switching the device off



Press the Mode-Button  till „OFF“ appears on the display.

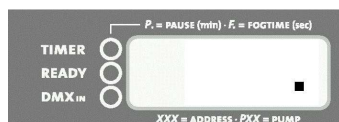

After 15 Seconds the machine will switch off automatically. On the right bottom edge of the display a red decimal point will appear.

You can also switch off the machine within these 15 seconds by pressing the Enter-Button. When you turn the DMX signal off, the machine will be switched automatically off after 15 seconds.

Please notice that the Mode-Button  is not appropriate to scrolling through the control panel.

You have to press the buttons separately. If you press the Mode-Button more than two seconds, the machine will change into the timer Mode.

5.3 Control System

5.3.1 External Control

You may control the **FIRE TRAINER** externally through the XLR sockets. Please note: DMX takes priority. That means: when the machine is controlled via DMX 512 this data takes priority over

- 0-10V (+) DC
- Optional cabelcontrol
- Optional radiocontrol

5.3.2 Operating via DMX 512

Connecting the **FIRE TRAINER** to a DMX desk, use the XLR socket beside the control panel. As soon as the machine receives a correct DMX signal, the yellow DMX LED will be lit.



DMX or analog input (depending on device)

Adjusting the DMX start address

Press the Mode button  at the control panel until three figures appear on the LED display

Adjust the required start address by pressing the Up or Down button.

Save the start address by pressing the Enter button once.

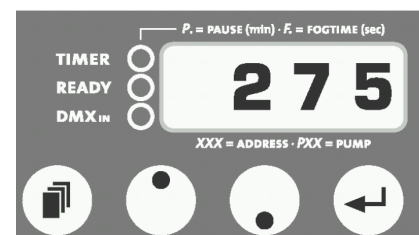

Now you are able to configure the performance of the pumps via DMX. If you turn off DMX, the **FIRE TRAINER** will be automatically switched off within 15 seconds.

FOG SMOKE FACTORY & HAZE

FOG AND HAZE GENERATORS

5.3.3 Stand-alone Betrieb



Our products fulfil all your needs!

The **SMOKE FACTORY - FIRE TRAINER** can be used in the stand alone mode. In this mode all data for the pump and the fan must be adjusted directly at the machine.

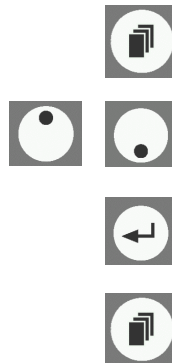
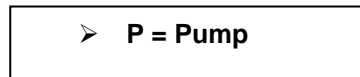

Press the Mode button  at the control panel until a "P" and two figures appear on the LED display

Adjust the desired data (1 - 99%) by pressing the Up/Down-Button.

By pressing the Enter-Button you switch the smoke machine and the optional fan on and off.

By pressing the Mode-button again  you return to the options.

SMOKE FACTORY

FOG AND HAZE GENERATORS

5.3.4 Radio Control (optional)



Connect the Fire Trainer to an analog desk or the optional cable remote, using the XLR socket at the back of the smoke machine.

Please use the correct socket. Put the cable from the desk or the cable remote into the XLR socket at the back of the machine. Put the pump up to 99% and adjust the required fan output at the machine.

With the rotary control on the cable remote or with the fader on the analog desk the pump output can be regulated. Pressing the On/Off switch at the cable remote starts the haze process.



DMX or analog input and cable remote,
(Depending on device)

Controls with optional radio remote

Connect the radio receiver with XLR socket and put the receiver in the device. If you press the remote control you start the hazing process. If you remove your finger from the Start-Button the hazing- and „wind“-process will end.

For further information please take a look at the instruction manual for the radio remote control.

XLR 3pol socket of the radio remote
control
Start-Button



5.3.5 Pin-Configuration

DMX:

Pin 1 = Ground (Mass)
Pin 2 = DMX-
Pin 3 = DMX+
Pin 4 und 5 = nc

3pol-XLR (analog):

Pin 1 = Ground (Mass)
Pin 2 = 0-10 V + DC in
Pin 3 = 12 V + DC out
max. 50mA

FOG & HAZE SMOKE FACTORY



FOG AND HAZE GENERATORS

6. Using the Timer

With the internal timer, the haze and wait time as well as the pump and fan output can be adjusted.

To start the Timer-Mode, press and hold the Mode button  for more than 2 seconds. The red Timer/Profile-LED will blink as soon as the machine has switched to the Timer-Mode. As long as the timer is in operation, the red Timer/Profile-LED blinks.



TIMER-LED / Red	
READY-LED / Green	
DMX IN-LED / Yellow	

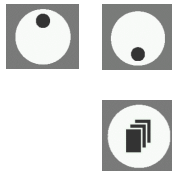
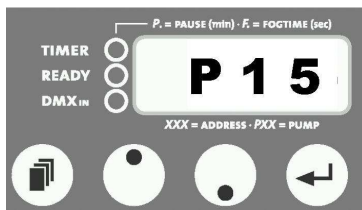

The adjusting of the output (1 – 99 %) is the same as in the Standard-Menu. This means you have to press the Mode button repeatedly until you reach the required function.

You can switch to the Wait-Menu by pressing the Mode button.

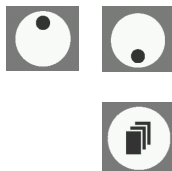

The adjusting of the wait time (0.1 – 99 minutes) is the same as in the Standard-Menu.

You can switch to the Haze-Menu by pressing the Mode button.



To adjust the „Fogtime“ press the Up/Down-Buttons (1 - 99 sec.).

SMOKE FACTORY

FOG AND HAZE GENERATORS



Pressing the Mode-Button will lead you to the option „Escape“ which you can see on the display.

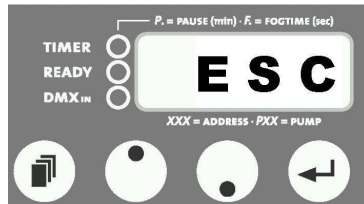

If you press the Enter-Button you will be led back to the Start-Display, where you started the adjustments.



The timer cycle starts with the time shown on the display when you press the Enter-Button (i. e. P.xx = Starts with wait time, F.xx = Starts with haze time). The timer cycle will not start if you press the Enter-Button while the pump or fan output setting is shown on the display. You can switch back to the Standard-Menu by pressing the Mode button for more than 2 seconds or by pressing the Mode-Button repeatedly until „ESC“ shows on the display and then press the Enter button once.

6.1 Auto start

If the timer is in operation and you unplug the machine from the power outlet, the **Fire Trainer** will re-start in the Timer-Mode as soon as it's reconnected.

FOG SMOKE FACTORY & HAZE

FOG AND HAZE GENERATORS

7. Maintenance



- Avoid overheating of the smoke machine by high operating temperatures. Don't let spotlights directly shine on the device.
- Do not let the smoke machine run without any fluid as the pump will run dry.
- Some droplets of condensation will form at the nozzle. That is normal and not a malfunction. Remove the fluid droplets as they can destroy the electronics.
- Check the state of the fluid filter from time to time and clean or replace it when necessary.
- Clean the fluid bottle before refilling it to avoid dirt that can cause malfunctions.
- If you install the **FIRE TRAINER** permanently you need to maintain a smoke- and fog-free air supply. Cooling air with concentrated fog can condensate in the device and lead to humidity damages.
- The altitude difference between the external canister and the device must not be more than 150 cm. Otherwise the pump won't be able to be draw the fluid.

FOG & HAZE SMOKE FACTORY

FOG AND HAZE GENERATORS

8. Trouble-Shooting

The Fire Trainer does not produce any haze

- Check the external control
- Check the power supply
- Check, if there is enough fluid in the canister
- Check if the connection is permeable
- Check if fluid tube is unclean



The Fire Trainer hazes uncontrolled

- Check the external control
- Check the humidity (High humidity can cause uncontrolled hazing)



The Fire Trainer deactivates itself

- The over temperature protection device is activated. Remove external heat sources, to maintain the air supply. The device will reactivate itself within 15 – 30 minutes.



Loud humming noise during hazing

- The pump runs dry. Avoid generating fog without fluid. Refill fluid!
- Check fluid tube, disconnect and reconnect.



E-2, E-3, E-4 appear on the LED display

- The machine is getting too hot. The heating switches off and the machine cools down.
- **Solution:** Disconnect the machine from the mains supply for a moment and then re-connect it.



E-1 appears on the LED display

Please send the machine to the service-station or your local dealer.



FOG SMOKE FACTORY & HAZE

FOG AND HAZE GENERATORS

9. Technical Specifications



On this page we provide you with the technical specifications of the device. Please notice that we response to all requirements and support you with highly skilled professionals.

Functional principle	Evaporator smoke machine
Electrical power	2600 W, additionally infinite variable power for fan, Maximum 800 W
Supply voltage	230V/50Hz
Fluid consumption	Maximum output 240ml/min Permanent hazing 120ml/min
Capacity of fluid bottle :	5 Litres - 25 Litres
Fog output:	Adjustable from 1 to 99 %, 1% - steps
Fogtime	100% output approximately 40 seconds <50% output permanent hazing
Control options	DMX 512 0-10 V analog Timer Stand alone
Heating-up time	Approximately 7 minutes
Temperature controlling	Microprocessor
Overheating protection	Heater block with thermostat Pump with temperature switch
Protection type	IP 65 according to DIN 40050-9 with closed lid IP 22 according to DIN 40050-9 with open lid
Working temperature :	-20 °C to +70 °C
Fineprotection for optional fan :	5 Ampere delay
Dimensions (WxHxL):	380 mm x 300 mm x 210 mm
Weight w/o fluid:	Approximately 14 kg
Volume	29,50 dm ³
Accessories	Radio remote and cable remote control
Scope of delivery	FIRE TRAINER, lid for 5 or 25 Litre canister, Mains supply, IP 68-plug

SMOKE FACTORY

FOG AND HAZE GENERATORS

Construction Dimensions

Side view/ Construction on the wall

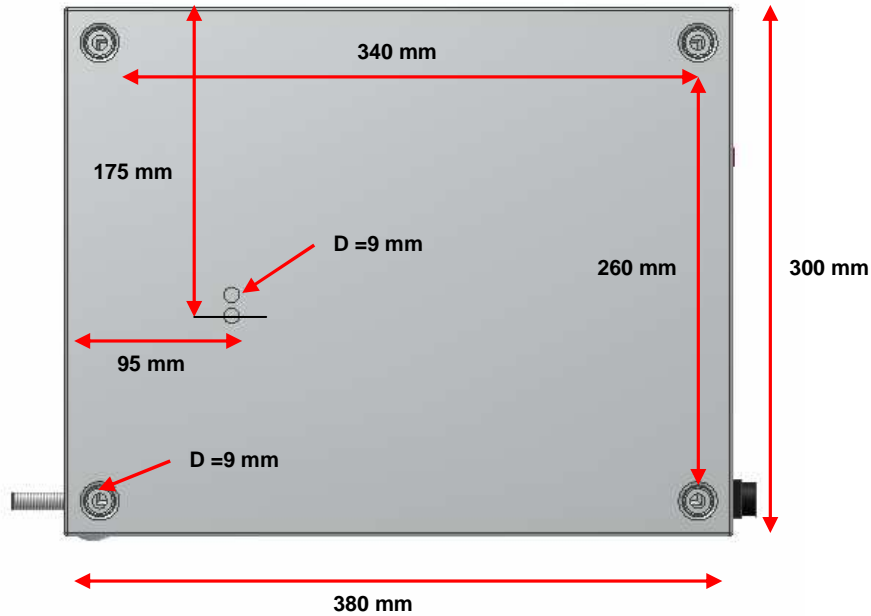

Please notice

- When mounted on the wall you need at least 40 cm of distance between device and wall.

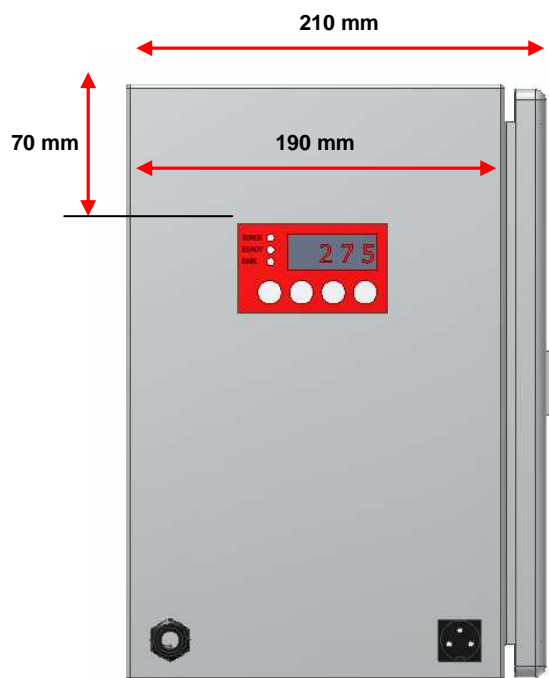

10. Warranty Conditions

Effective only for the Federal Republic of Germany

SMOKE FACTORY grants you warranty for the „Fire Trainer“ according to the following conditions:

1. Free of charge, subject to the following conditions (No. 2 - 6) we will repair any defect or fault in the unit if it is caused by a proven factory fault and has been advised immediately after appearance and within 6 month of delivery to the end user. Insignificant deviations of the regular production quality does not guarantee replacement rights, nor do faults or defects caused by water, by generally abnormal environment conditions or Force Majeure.
2. Guarantee Service will be done in the following way: Faulty parts will be repaired or replaced according to our choice with the correct parts. Faulty units have to be brought to us or our service centres or to be sent to us or our service centres at customer's expenses. The invoice and/or receipt showing the purchase date and the serial number has to come with the faulty unit, otherwise this will not be guarantee service. Replaced parts become our property.
3. The customer loses all rights for guarantee services, if any repairs or adjustments are done to the units by unauthorized persons and/or if spare parts are used which are not approved by us. The right of guarantee service is also lost if fluids other than the original SMOKE FACTORY-fluid have been used or if units are sent to us with full fluid bottles. Also non compliance with the instructions in this manual or mistakes by incorrect handling/treating of the machine will lead to a loss of guarantee and also any faults and damages caused by undue force.
4. Carrying costs caused to warranty services are borne by the customer himself.
5. Guarantee services do not cause an extension of the guarantee time or the start of a new guarantee time. The warranty for replaced parts ends with the guarantee time of the whole device.
6. If a defect/fault can not be repaired by us in a satisfactory time, we will, within 6 months after sale of the unit, on choice of the customer, either:
 - replace the whole unit for free or
 - refund the lesser value or
 - take back the whole unit and refund the purchase price, but not more than the usual market price at the time of the refund.
7. Further claims, especially for damages, losses etc. outside the unit are excluded, if the liability is not statutory.

Outside the Federal Republic of Germany the warranty conditions of our local agencies take effect. Our local agencies in and outside the Federal Republic of Germany will provide you with the warranty conditions any time. In case you send the FIRE TRAINER make sure that the fluid is removed from the bottle.

FOG **SMOKE FACTORY** & HAZE

FOG AND HAZE GENERATORS

11.Service

See the Performance

We inform you

We help you

We provide you with information material fast und reliably

Service and Contact

Fog, Smoke & Haze Factory GmbH
Walsroder Str. 159 A
D-30853 Langenhagen/Hannover

Tel.: ++49 (0) 511 - 51 51 02 - 0
Fax: ++49 (0) 511 - 51 51 02 - 22

Email: info@smoke-factory.de
Internet: www.smoke-factory.de

Responsible for content: Fog, Smoke & Haze Factory GmbH

[Design & Arrangement / www.devtecs.de](http://www.devtecs.de)

www.smoke-factory.de