

Importateur  
B&K Lumitec  
2 rue Alfred Kastler  
Zone industrielle  
67850 HERRLISHEIM  
[www.bklumitec.com](http://www.bklumitec.com)  
[info@bklumitec.com](mailto:info@bklumitec.com)



# Stage Profile Zoom

17-50° 200W DMX RGBW



Operating Manual

### 1.Packing List



LED Profile Light



Power Cable



Manual

### 2.Measurements

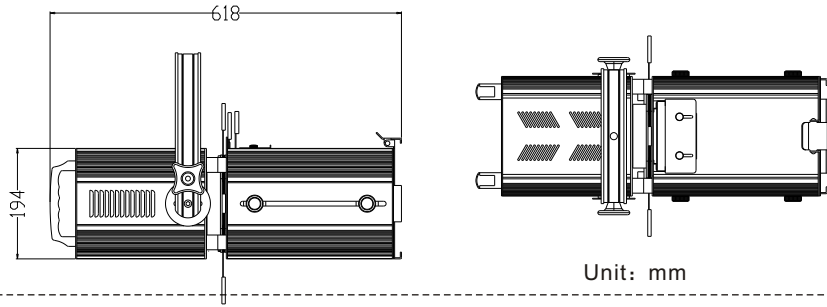

### 3.Wiring Diagram

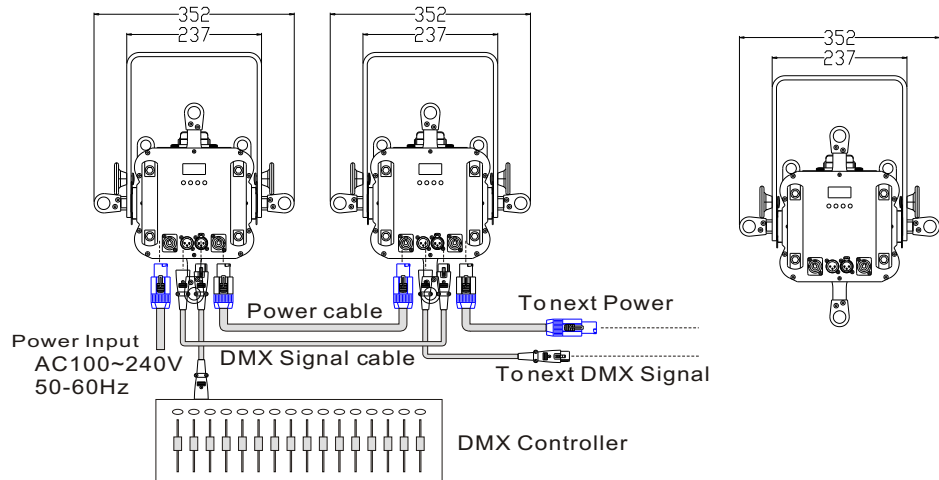

### 10.Notes

---

---

---

---

---

---

---

---

---

---

---

---

---

---

---

---

---

---

---

---

---

---

---

## 9. Function

### DMX Mode

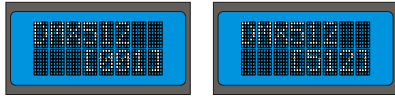
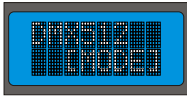

DMX Address Allocation: 001-512

### DMX 9 Channels

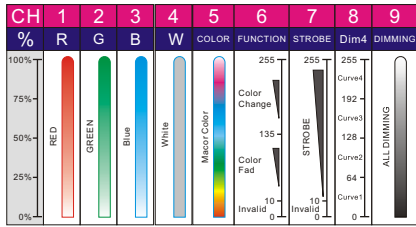

### Dimming Mode

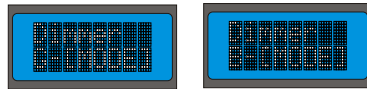
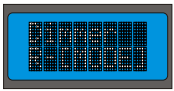

Brightness adjust: 0001-4096 Dimming

### Strobe Mode

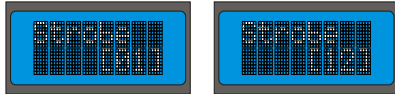
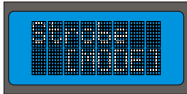

Strobe/Speed : 01-12 Dimming

### Fade Mode

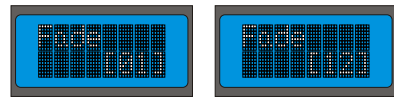
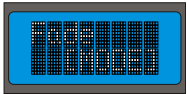

Fade/Speed : 01-12 Dimming

### Auto Mode

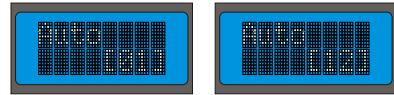
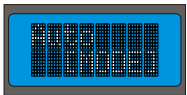

Auto/Speed : 01-12 Dimming

### Master/Slave Setting

1, Master: Dimming /Strobe/Fade/AutoMode

2, All Salves: DMX001 (as below)

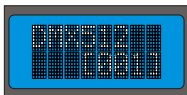

## 4. Illumination Diagram

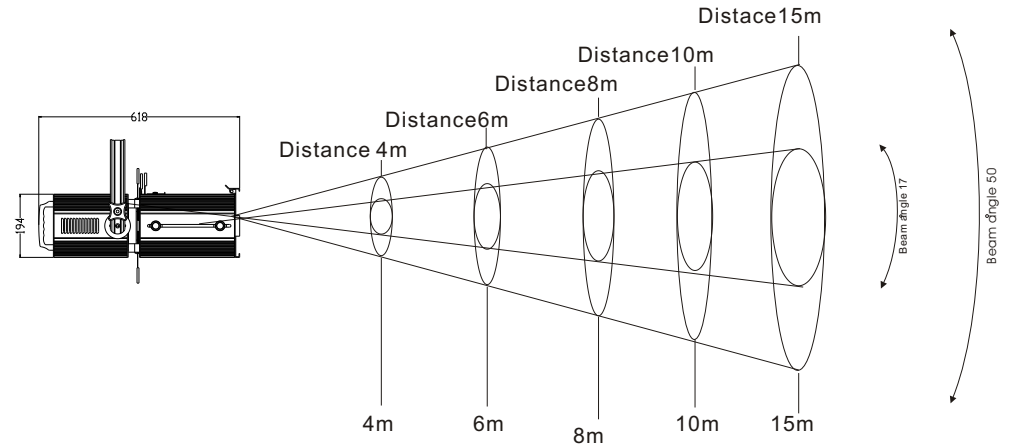

Illumination Center/Lux	R	560	275	202	135	110	Beam angle 17°
	G	750	390	250	240	148	
	B	950	495	320	308	175	
	W	1010	490	332	325	176	
Beam Diameter/cm		120	179	240	299	449	
Illumination Center/Lux	R	230	110	75	60	53	Beam angle 50°
	G	320	170	103	80	75	
	B	338	175	105	95	80	
	W	335	170	101	91	85	
Beam Diameter/cm		225	378	429	631	946	

## 5. Installation

### Hanging



## 6. Technical parameters

LED Source	1x LED COB RGBW 4en1 200W
Optical group	Beam angle :17-50degree with high-efficiency optical system
Control	9 DMX channels;LCD display+4 soft keys;4 selectable dimming curves
Connection	Powercon In & Out; 3-pole DMX In & Out(5-pole DMX available)
Voltage	AC 100-240V 50/60Hz
Max Power	200W
Measurements	Size: 61.5X28X21.5cm Weight: 11Kg

## 7. Control Panel

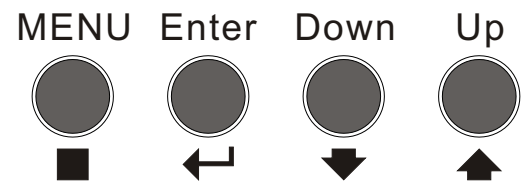
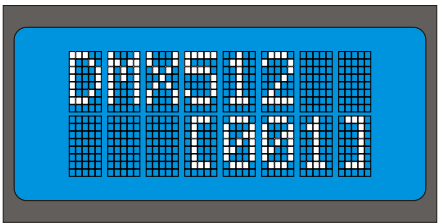

- Adjust keys function on panel
- Press "MENU" --->Display first-level menu--->  
 Press "Enter" --->Display second-level menu--->  
 Press "Down" & "Up" to adjust relevant function--->  
 Press "Enter" and "MENU" to quit current menu--->  
 Press "MENU" --->To next first-level menu...

## 8. Menu

