

Importateur

B&K Lumitec

2 rue Alfred Kastler

Zone industrielle

67850 HERRLISHEIM

[www.bklumitec.com](http://www.bklumitec.com)

[info@bklumitec.com](mailto:info@bklumitec.com)



# Stage Profile Zoom

## 17-50° 200 Watts



Notice d'utilisation

### 1.Packing Liste



LED ProfileLight



Cordon secteur

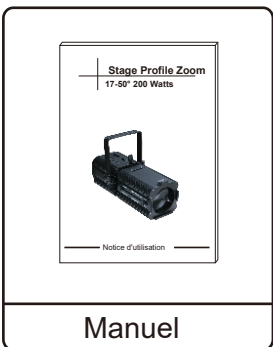

Manuel

### 2. Dimensions

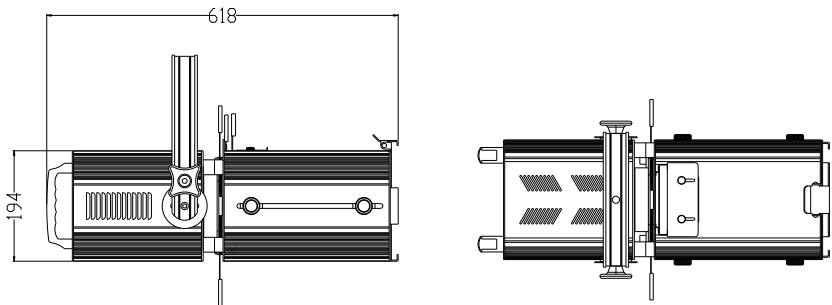

### 3.Câblage

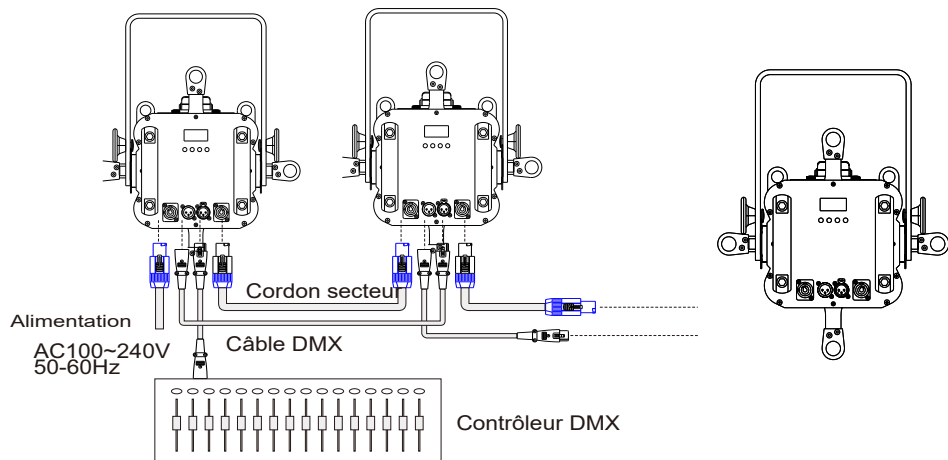

### 10.Notes

---

---

---

---

---

---

---

---

---

---

---

---

---

---

---

---

---

---

---

---

---

---

---

---

---

---

---

---

---

---

## 9. Fonctions

### Mode DMX

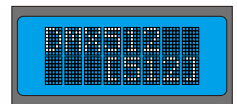
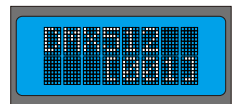
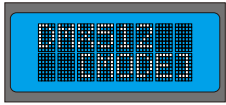

Adresse DMX : 001-512

### DMX 1 Canal

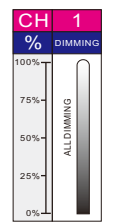

### DMX 2 Canaux

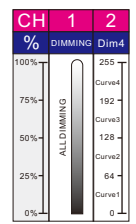

### DMX 3 Canaux

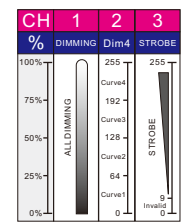

### Mode Dimmer

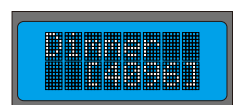
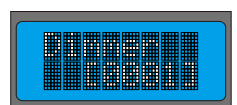
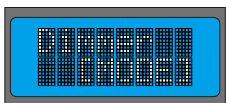

Luminosité : 0001-4096

### Mode Strobe

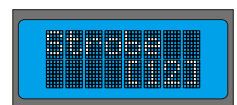
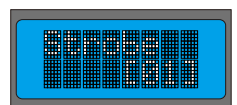
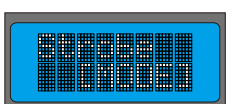

Vitesse strobe : 01-12

### Canaux DMX

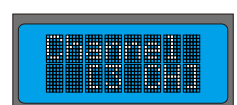
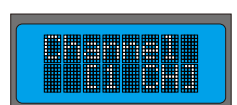
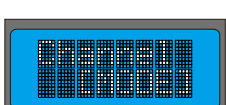

Choix du mode : 1 - 3 Canaux

### Mode Master/Slave :

1. Master: Mode Dimmer, Mode Strobe, Canaux DMX
2. Slave: DMX001 (voir ci-dessous)

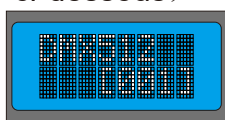

## 4. Données photométriques

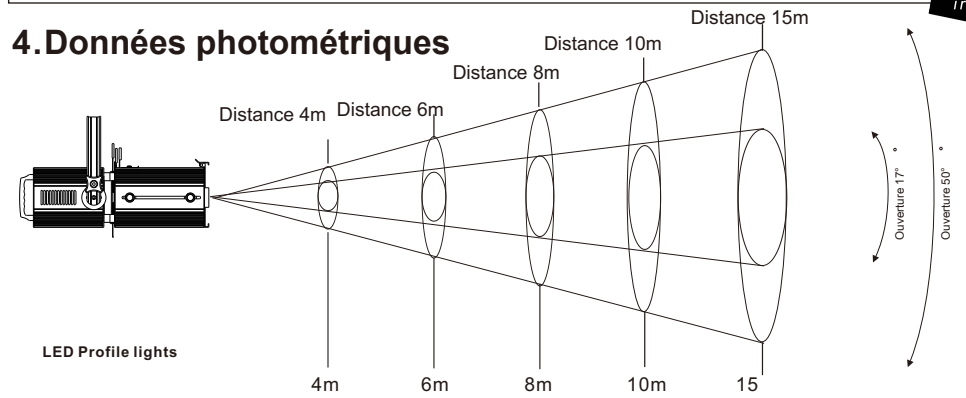

LED Profile lights

3200K

	4m	6m	8m	10m	15m	
Luminosité / Lux	4600	1765	1140	850	390	Ouverture 17° °
Diamètre faisceau / cm	120	179	240	299	449	
Luminosité / Lux	1510	690	500	440	195	Ouverture 50° °
Diamètre faisceau / cm	225	378	429	631	946	

## 5. Installation



## 6. Descriptif

Source LED	1xLED 200W (3200K), CRI>90;
Système optique	Ouverture 17-50 degrés
Contrôle	DMX 1/2/3 canaux; manuel
Connection	Powercon In & Out; DMX XLR 3 points In & Out
Alimentation	AC100-240V 50/60Hz
Conso Max.	200W
Dimensions	61.5X28X21.5cm Poids 11Kg

## 7. Panneau de contrôle

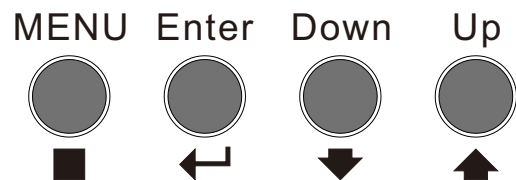
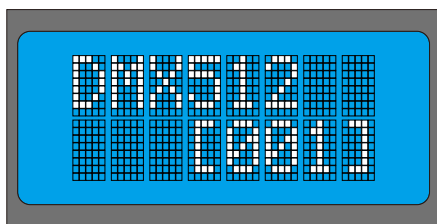

### ■ Touches de paramétrage

- Press MENU ---> Premier menu --->
- Press Enter ---> Second menu --->
- Press Down&Up variation valeurs --->
- Press Enter et MENU pour sortir --->
- PressMENU ---> Menu suivant --->

## 8. Menu

