

Importateur

B&K Lumitec

2 rue Alfred Kastler

Zone industrielle

67850 HERRLISHEIM

www.bklumitec.com

info@bklumitec.com



Stage Profile Zoom

17-50° 200 Watts



Operating Manual

1.Packing List



LED ProfileLight



Power Cable

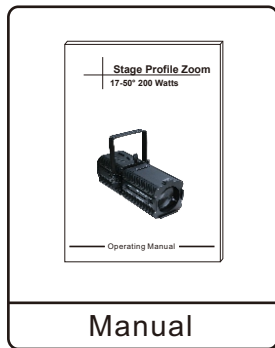

Manual

2.Measurements

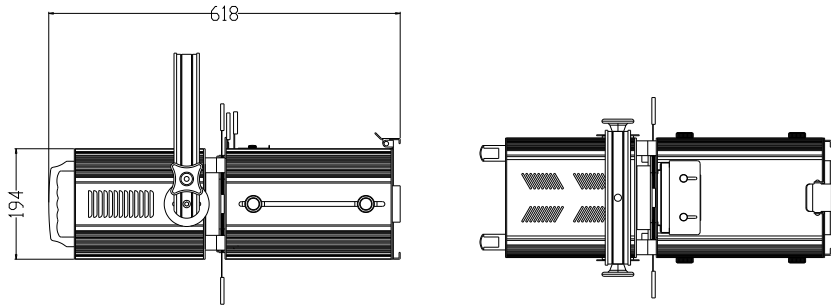

3.Wiring Diagram

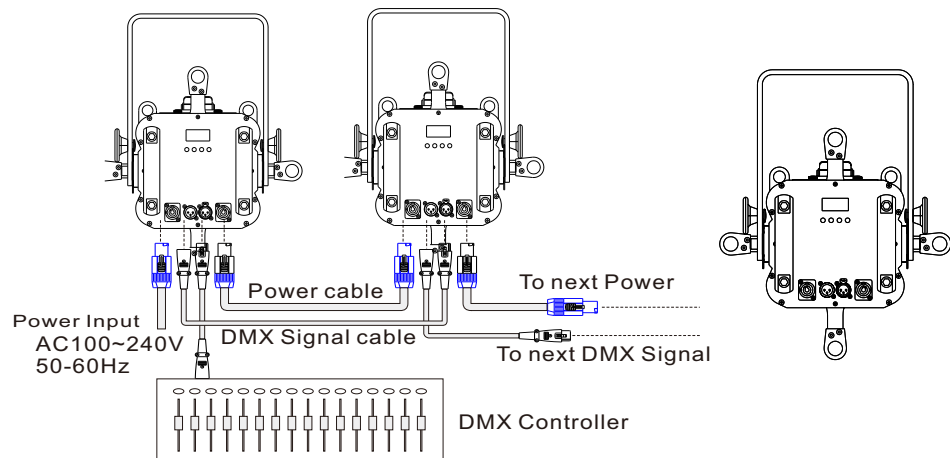

10.Notes

10 horizontal dashed lines for notes.

9.Function

DMX Mode

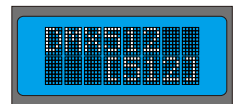
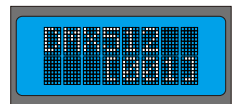
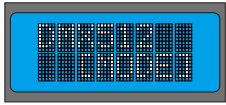

DMX Address Allocation: 001-512

DMX 1 Channels

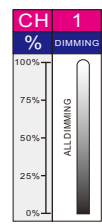

DMX 2 Channels

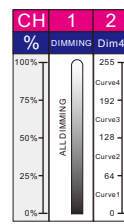

DMX 3 Channels

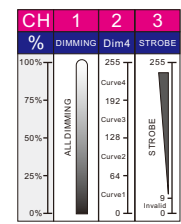

Dimming Mode

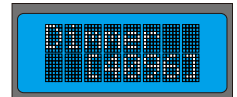
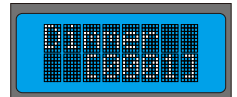
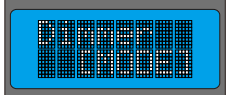

Brightness adjust: 0001-4096 Dimming

Strobe Mode

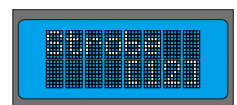
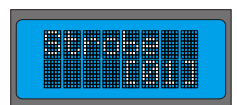
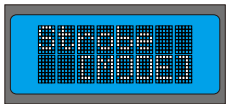

Strobe/Speed : 01-12 Dimming

Channel Mode

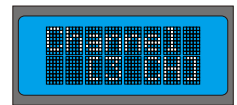
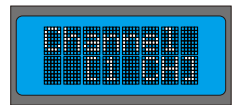
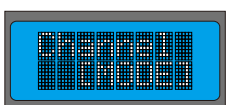

Channel adjust: 1 - 3 Channel

Master/Slave Setting:

- 1, Master: Dimming Mode/ Strobe Mode/Channel Mode
- 2, All Slaves: DMX001 (as below)

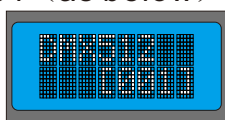

4.Illumination Diagram

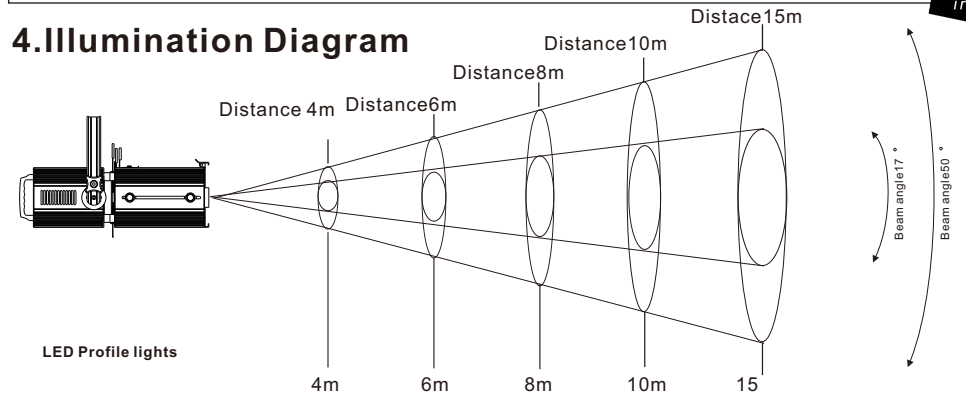

LED Profile lights

| 3200K | | | | | | |
|-------------------------|------|------|------|-----|-----|----------------|
| Illumination Center/Lux | 4600 | 1765 | 1140 | 850 | 390 | Beam angle 17° |
| Beam Diameter/cm | 120 | 179 | 240 | 299 | 449 | |
| Illumination Center/Lux | 1510 | 690 | 500 | 440 | 195 | Beam angle 50° |
| Beam Diameter/cm | 225 | 378 | 429 | 631 | 946 | |

5.Installation



6. Technical parameters

| | |
|---------------|--|
| LED Source | 1xLED 200W (3200K), CRI>90; |
| Optical group | Beam angle 17-50degree with high-efficiency optical system |
| Control | DMX 1 2 3 channels Optional ;LCD display+4 soft keys;4 selectable dimming curves |
| Connection | PowerconIn & Out; 3-pole DMX In & Out (5-pole DMX available) |
| Voltage | AC100-240V 50/60Hz |
| Max Power | 200W |
| Measurements | Size 61.5X28X21.5cm Weight 11Kg |

7. Control Panel

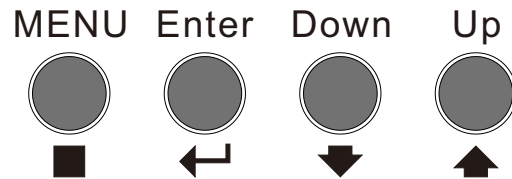
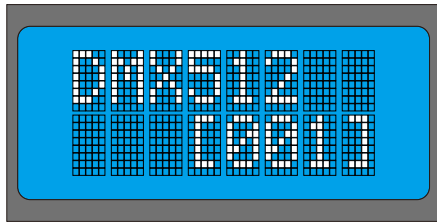

- Adjust keys function on panel
- Press MENU --->Display first-level menu--->
Press Enter --->Display second-level menu--->
Press Down & Up to adjust relevant function--->
Press Enter and MENU to quit current menu--->
Press MENU --->To next first-level menu...

8. Menu

