

**MAGICFX<sup>®</sup> STAGE FLAME**

PRODUCT CODE :MFX1201  
VERSION :1.0  
DATE :14.12.2012



## **1. CONGRATULATIONS!**

You have purchased a wonderful new product from MAGICFX®.



MAGIC FX is a Dutch manufacturer of professional special effects machinery and equipment. We have specialised in special effects since we established our business in 1995. All products are manufactured under the brand name MAGICFX®, which has acquired an excellent reputation for quality and reliability. All products are manufactured in accordance with the European Machinery Directive. MAGIC FX handles the entire production in-house from concept to finished product. We take care of the design, prototyping and manufacturing process.

MAGIC FX is also Europe's largest supplier of high quality and fireproof confetti products and streamers. We keep a large inventory in stock so we can deliver speedily and at the lowest prices.

MAGICFX® products are used by special effects professionals around the world and distributed by a dealer network across 58 countries.

Thank you for your purchase!

## 2. CE MARKING

	<p><b>NOTE:</b> We must assume that you, your employees and others who use or come into contact with the machine are familiar with how the machine should be utilized. This specifically pertains to the proper use, maintenance and repair of the machine as described in this user manual. This also means that employees should be qualified to use machinery through training or experience.</p>
	<p><b>DANGER WARNING:</b> The Stage Flame must only be used according to the prescriptions and instructions in this manual. Consult MAGIC FX if there are any doubts about usage.</p>

Disclaimers:

MAGIC FX B. V. specifically disclaims liability for unsafe situations, accidents and damages caused by:

- Ignoring warnings or prescriptions displayed on the Stage Flame or in this documentation.
- Using the equipment for other purposes or situations than specified in this documentation.
- Modifications to the Stage Flame. This includes the use of non-original spare parts.
- Improper maintenance.
- Unauthorized removal of safety covers and/or safety devices.
- Improper use of the machine.

MAGIC FX B.V. is not liable for any damages due to failures of the Stage Flame.

© Copyright 2012

All rights reserved. No part of this manual may be reproduced, stored in a retrieval system or transmitted in any form or by any means, electronic, mechanical, photocopied, recorded or otherwise without the prior written permission of MAGIC FX B.V.

MAGIC FX reserves the right to make modifications at any time without having to notify the customer beforehand. The content of this manual may also be modified.

For additional information about maintenance, repair, and so on, please contact your supplier's technical department. This manual was written with the utmost care. MAGIC FX cannot be held liable for errors contained in this document or consequences thereof.

### 3. DECLARATION OF CONFORMITY

---

**DECLARATION OF CONFORMITY**  
(according to Annex IIA of the Machinery Directive)



With respect to the Machinery Directive.  
MAGIC FX B.V.  
Industrieweg 16  
5281 RW Boxtel  
The Netherlands

Hereby declares under our sole responsibility:  
We are the manufacturer of the product:

**MFX1201 - MAGICFX® Stage Flame**

to which this declaration pertains and it is in conformity with the provisions of the following guidelines:

- Machinery Directive 2006/42/EG
- Low Voltage Directive 2006/95/EG
- EMC Directive 2004/108/EG

The following harmonized standards are applicable:

- NEN-EN-ISO 12100-1
- NEN-EN-ISO 12100-2
- NEN-EN-ISO 13850
- NEN-EN-ISO 13732-1
- NEN-EN 60204-1

City: Boxtel  
Date : 08-06-2010

Name: MAGIC FX

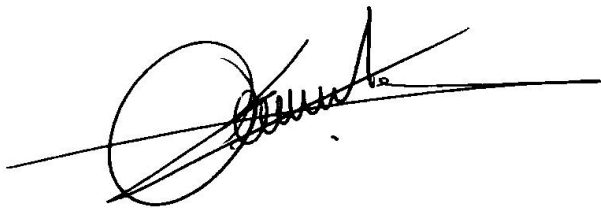

Director: B. Veroude





## 4. FOREWORD

This manual provides pertinent information about the MAGICFX® Stage Flame. The information in this manual is important with respect to the proper and safe operation of the Stage Flame. If you are not familiar with the installation, operation, preventive maintenance, etc., of the Stage Flame then read this manual in its entirety. MAGIC FX also urges all new users (operators, installers, maintenance staff and possibly cleaning staff) to receive training on the equipment using this manual as the basis for the training.

MAGIC FX recommends you keep the original of this manual and its attachments in a secure central location, and, keep another copy of this manual close to the workplace where the Stage Flame will be used.

If you are well acquainted with the proper handling of the equipment then keep this manual handy for reference.

The following conventions are used in this manual to draw your attention to specific information or actions.

	<p><b>TIP:</b> This provides you with suggestions and advice on how to perform tasks in an easier or more convenient way.</p>
	<p><b>NOTE:</b> This is a note providing supplemental information that alerts you to possible problems.</p>
	<p><b>CAUTION:</b> This indicates that the equipment may be damaged if procedures are not carried out in the proper manner.</p>
	<p><b>DANGER WARNING:</b> This indicates that you may cause yourself injury, possibly serious, if procedures are not carried out in the proper manner.</p>

## TABLE OF CONTENTS

<b>1.</b>	<b>CONGRATULATIONS!</b> .....	<b>1</b>
<b>2.</b>	<b>CE MARKING</b> .....	<b>2</b>
<b>3.</b>	<b>DECLARATION OF CONFORMITY</b> .....	<b>3</b>
<b>4.</b>	<b>FOREWORD</b> .....	<b>4</b>
<b>5.</b>	<b>INTRODUCTION</b> .....	<b>6</b>
5.1	<b>DESCRIPTION OF THE STAGE FLAME AND ITS USAGE</b> .....	<b>6</b>
5.2	<b>NECESSARY ACCESSORIES</b> .....	<b>6</b>
5.3	<b>TYPES OF GAS</b> .....	<b>6</b>
5.4	<b>CHOICE OF FLAME</b> .....	<b>7</b>
<b>6.</b>	<b>SAFETY</b> .....	<b>8</b>
6.1	<b>INTRODUCTION</b> .....	<b>8</b>
6.2	<b>GENERAL SAFETY RULES</b> .....	<b>8</b>
6.3	<b>EMERGENCY STOP BUTTON</b> .....	<b>8</b>
6.4	<b>WARNINGS</b> .....	<b>9</b>
6.5	<b>FEATURES</b> .....	<b>10</b>
<b>7.</b>	<b>PARTS</b> .....	<b>11</b>
<b>8.</b>	<b>ACCESSORIES</b> .....	<b>12</b>
<b>9.</b>	<b>PREPARATION FOR USE</b> .....	<b>12</b>
<b>10.</b>	<b>READYING FOR USE</b> .....	<b>13</b>
<b>11.</b>	<b>USAGE</b> .....	<b>19</b>
<b>12.</b>	<b>TURNING OFF</b> .....	<b>21</b>
<b>13.</b>	<b>TROUBLESHOOTING</b> .....	<b>21</b>
<b>14.</b>	<b>TECHNICAL SPECIFICATIONS</b> .....	<b>22</b>
<b>15.</b>	<b>MAINTENANCE</b> .....	<b>22</b>
<b>16.</b>	<b>GUARANTEE</b> .....	<b>22</b>

## 5. INTRODUCTION

### 5.1 DESCRIPTION OF THE STAGE FLAME AND ITS USAGE

The Stage Flame is a device specifically designed for producing flames on stage. The Stage Flame is intended solely to be placed on a flat surface or stage and produce brief upward flame effects (fire balls).

Should you use the equipment in any way other than just described then you release your supplier from all liability.

The Stage Flame can be used with approved aerosol cans and propane gas bottles. The Stage Flame also has a large flame mode where both aerosol can and gas bottle are used at the same time. The Stage Flame is DMX controllable. One address is used as a safety channel and one address for the flame. A third address is used for the big flame mode.

The Stage Flame has a large number of safety features and components that are discussed later in this manual. Read this manual carefully in its entirety before you start working with the Stage Flame.

### 5.2 NECESSARY ACCESSORIES

The following parts are necessary with the Stage Flame:

		
Manual	MFX0308 – POWER CABLE	MFX1204 – EMERGENCY STOP

Table 5.1

### 5.3 TYPES OF GAS

The Stage Flame can use approved aerosol cans (with screw-thread connector) and propane gas bottles.



		
AEROSOL CAN	GAS BOTTLE	

Table 5.2

### 5.4 CHOICE OF FLAME

The following types of flames are possible (at a normal ambient temperature of 20°):

- AEROSOL CAN: Flame height approximately three meters high
- GAS BOTTLE: Flame height approximately three to four meters high
- BIG-FLAME (AEROSOL CAN + GAS BOTTLE): Flame height approximately six meters high





MODE	FLAME HEIGHT	MINIMUM CLEARANCE HEIGHT
AEROSOL CAN	 3M	6M
GAS BOTTLE	 4M	7M
<b>BIG-FLAME</b> (AEROSOL CAN + GAS BOTTLE)	 6M	10M

Table 5.3

	<b>DANGER WARNING:</b> As the ambient temperature increases so does the gas pressure and that leads to a higher flame.
	<b>DANGER WARNING:</b> An invisible hot vapor is created above the flame. At all times, ensure that the minimum clearance height is kept clear when the Stage Flame can be activated.



## 6. SAFETY

### 6.1 INTRODUCTION

The Stage Flame is designed and constructed so that it can be used in a safe manner. Specifically, this refers to the usage, situations, and prescriptions for the device as described in this documentation. It is the responsibility of all persons authorized to use the Stage Flame to read and follow the instructions in this manual.

The Stage Flame should be located and used in an environment that preferably:

- Has a fairly constant temperature between 0 and 30°C.
- Has a relative humidity not exceeding a maximum of 75%.
- Is reasonably free of dust, corrosive gases, and high concentrations of organic vapors.
- Does not contain any source of vibrations in the environment.

The Stage Flame is designed and constructed so that it can be used in a safe manner. Specifically, this refers to the usage, situations, and prescriptions for the device as described in this documentation. It is the responsibility of all persons authorized to use the Stage Flame to read and follow the instructions in this manual.

### 6.2 GENERAL SAFETY RULES

- The Stage Flame should only be used when there are no people, animals, or inflammable objects within the danger zone. The danger zone is the cylindrical space around the device with a radius of three meters. See also the red shading in Figure 3 (not drawn to scale).
- Ensure that the Stage Flame is not accessible to children, unauthorized persons, or animals!
- Do not touch the Stage Flame when it is operational or turned on. Even if the device is not in operation it might be ready to activate.
- Safety devices must not be removed or rendered inoperative.
- All required safety devices should be in good working order and functioning properly.
- Ensure that there is adequate lighting in the environment.
- Keep the workplace clean.
- Only authorized persons may work with the Stage Flame.
- It not permitted to use the Stage Flame in an environment containing flammable gases or fluids.
- Always ask the fire brigade for permission to use the Stage Flame at the desired location.

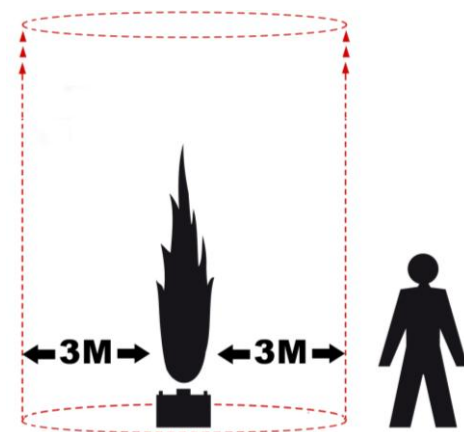

### 6.3 EMERGENCY STOP BUTTON

The Stage Flame is equipped with an emergency stop button (MFX1201) in case of emergencies. The Emergency Stop Button has the following characteristics:

- The emergency button is easy to recognize because of its red/yellow colors and should be positioned so that it can be reached easily and quickly.
- Pressing the emergency stop button immediately stops the Stage Flame. The emergency stop button remains mechanically blocked and the device cannot be restarted.

In the event of personal injury, immediate assistance can be given straight away. Any other emergency procedures should also be carried out as soon as possible.

The Stage Flame can be reset after the danger is entirely eliminated.

The emergency stop button also can be used if there is a sudden danger such as a malfunction. Such a situation does not require urgent action. The device can be simply turned off.

Further safety measures may be required depending on the nature of how the device will be used. See the relevant prescriptions.

Recommendations:

- Have new operators practice several times with the emergency stop button.
- Do not use the emergency stop button to stop the device in normal circumstances.
- Regularly test that it is working properly.
- An emergency stop button should not be reset when it is not known who or why it was used.

## 6.4 WARNINGS

There are several warnings displayed on the Stage Flame to which the following restrictions apply:

- The text must not be removed or otherwise spoilt. The operator should regularly check that the warnings are in good condition.
- The operator must ensure that the text is always visible and legible and that it remains so.

	<p><b>DANGER WARNING:</b> Any missing, spoilt, or illegible text or icons must be replaced.</p>
---	---

The icons used are shown below:

Icons	Explanation
 <p>PIC 616 Observe directions for use</p>	<p>Make the operator aware that they may only use the device after they have read the user manual.</p> <p>This warning is indicated with this instruction icon.</p>

Icons	Explanation
 <p>PIC 307 Hazardous voltage</p>	<p>This warning icon indicates the presence of dangerous live voltage.</p>

Icons	Explanation
-------	-------------

 <p data-bbox="381 472 625 501">PIC 315 Hot surface</p>	<p data-bbox="810 172 1353 262">A warning for danger from a hot surface must be indicated using the PIC 315 icon. This is located on the top of the Stage Flame.</p>
--	--

Icons	Explanation
 <p data-bbox="304 956 703 985">PIC 300 Combustible substances</p>	<p data-bbox="810 656 1362 745">A warning for danger for fire must be indicated using the PIC 300 icon. This is located on the top of the Stage Flame.</p>

## 6.5 FEATURES

The Stage Flame has many safety features. One of these features checks whether the Stage Flame is moved, tilted, or was given a massive jolt.

In these cases, the Stage Flame automatically stops and it will not be possible to create flames.

If the Stage Flame experiences a failure or is moved then the message “error press reset” will appear on the display window.

The Stage Flame can be made ready for use again by pressing and holding the reset button for three seconds.

## 7. PARTS

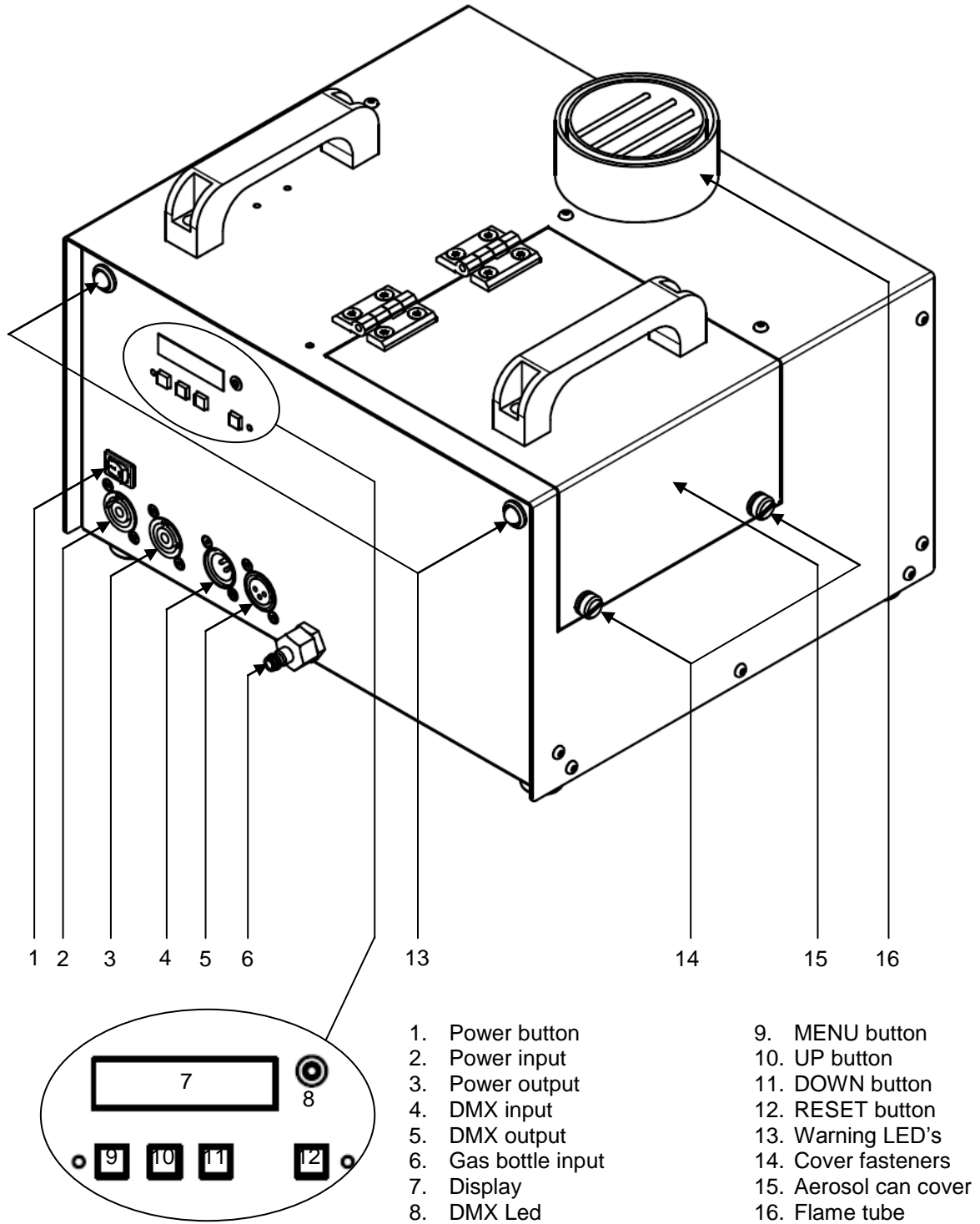

## 8. ACCESSORIES

		
<p><b>MFx1203 – GAS HOSE</b></p>	<p><b>MFx1202 – GAS REDUCER</b></p>	<p><b>MFx1204 – EMERGENCY STOP</b></p>

Table 8.1



You can order the above parts from:

<p>MAGIC FX B.V.            Industrieweg 16            NL-5281 RW BOXTEL            The Netherlands            Tel: +31(0)411 63 50 13            Fax: +31(0)411 63 50 12            Web: <a href="http://www.magicfx.eu">http://www.magicfx.eu</a>            Email: <a href="mailto:info@magicfx.eu">info@magicfx.eu</a></p>	
--	---

## 9. PREPARATION FOR USE

Unpack the Stage Flame. Dispose of packaging material without causing harm to the environment. Check the device for any possible damage. You must report any damage to the device to MAGIX FX.

## 10. READYING FOR USE

	<p><b>CAUTION:</b> This indicates that the equipment may be damaged if procedures are not carried out in the proper manner.</p>
	<p><b>DANGER WARNING:</b> The MAGICFX® Stage Flame may only be worked on by authorised adults.</p>

Prepare the Stage Flame for use as follows:

1.



Place the Stage Flame on a flat, solid, and stable surface.



For indoor use with aerosol cans, the minimum clearance height above the Stage Flame is six meters. For indoor use with gas bottles, the minimum clearance height is seven meters.  
For Big Flame mode, the minimum clearance height is at least ten meters.

2.



Ensure the Power button is set to “off”. Connect the power cable. The Stage Flame runs on 230V~ 50/60Hz. You will need a powerCON plug to be able to connect the Stage Flame to the power supply. The Stage Flame is delivered with a powerCON looping cable. It can be used to connect multiple Stage Flame devices up to the same power source.

3.



Connect a 3-pole DMX cable to the Stage Flame.

Optionally, you can link multiple Stage Flames together using 3-pole DMX cables.

4.



Connect the other end of the DMX cable (male plug) to a Professional DMX Controller.



Ensure that the controller is placed so that the operator always has a complete view of all the connected Stage Flames.



Consult the DMX controller manual for usage and safety instructions.

5.



Set the Stage Flame power button to "on".

6.



If you are going to use an aerosol can then open the cover of the Stage Flame.



The Stage Flame indicates that the door is open and automatically disables itself for use. In addition, a LED light will turn on making it possible to see in places that would otherwise be dark in the Stage Flame.

7.

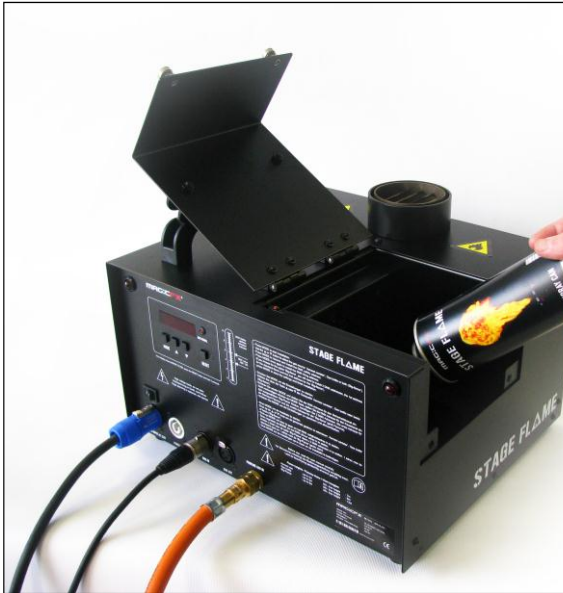

The aerosol cans are described elsewhere in this manual. Screw the aerosol can into the holder until it is securely locked in place. Ensure that it is securely in place.

**Only replace an aerosol can during a show when the Stage Flame is set to “safe mode”.**



Consult the DMX settings to see how the Stage Flame can be put into “safe mode”.

8.



The temperature will rise after the Stage Flame has been in use for a period of time. So always let the Stage Flame cool off before replacing the aerosol can. Always remember that escaping gas can ignite at high temperatures.

**After you have inserted/replaced the aerosol can, shut the cover of the Stage Flame and secure the fasteners on the side.**

9.



If you use a gas bottle, ensure that it is located on a safe flat surface beyond the reach of other heat sources. Fit the reducer onto the gas bottle.



Use the appropriate spanner to connect the reducer and ensure that no gas can escape.

**Ensure that the gas bottle cannot topple. This would allow liquid gas to enter the Stage Flame.**



1  
0.

Connect a quick release propane hose to the reducer. All propane hoses in our selection come standardly equipped with quick release connectors.

1  
1.

Flame height can also be controlled by adjusting the reducer. The bolt on top of the reducer should be turned to the maximum extent to allow for the greatest flow.



We recommend turning the bolt to the maximum opening to get the best results. The reducer must never be used without a bolt on the reducer. So never unscrew the bolt completely.

1  
2.

Attach the other quick release connector of the propane hose to the Stage Flame.

1  
3.



The Stage Flame settings should be selected only after all the connections are completed and the gas bottle and/or aerosol can is installed.



When readying the device, ensure that free channels are used on the DMX controller and that these channels are in safe mode. Safe mode means that those channels are set to a value of zero when readying the Stage Flame. Consult the DMX controller manual for instructions on changing its settings.

1  
4.

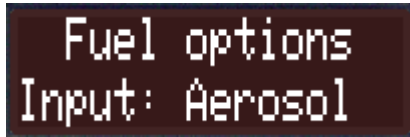

Press the MENU button so you can change settings for the Stage Flame.

The Stage Flame has three different options for creating flames. These options are dependent on the gas sources you choose to use.

The three options are:

Option 1 – Aerosol can

Option 2 – Propane cylinder

Option 3 – Big Flame (aerosol can and gas bottle)

You select the desired option by using the UP and DOWN buttons.

1  
5.

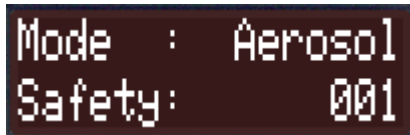

Press MENU again to save your selection. Now the DMX addresses need to be entered. First, the “safety” address needs to be set. You select the channel by using the UP and DOWN buttons. Press the MENU button to save the setting.

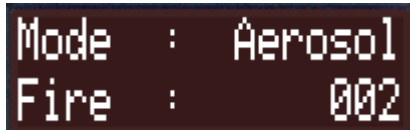

When using multiple Stage Flames, we recommend that you use the same “safety” channel for all of the devices.

**1  
6.**

Mode : Aerosol  
Fire : 002

After you have set the “safety” channel, you can set the “fire” channel. You select the channel by using the UP and DOWN buttons. If you have selected the “Big Flame” option then you must set two channels in this step. You can set the “small” flame and the “big” flame. Press the MENU button to save each setting.

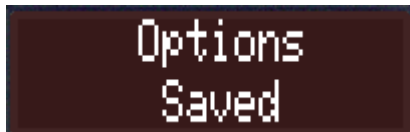

You may select separate “fire” channels for each Stage Flame that you have connected. This allows you to put some variety into your show.

**1  
7.**



Options  
Saved

At this point, you have completed all the steps to ready the DMX so you must now save the settings. Press the MENU button and the message “options saved” will appear in the window.



If you selected the “Big Flame” option then you should have also connected both an aerosol can and a gas bottle.

## 11. USAGE

	<p><b>TIP:</b> This provides you with suggestions and advice on how to perform tasks in an easier or more convenient way.</p>
	<p><b>CAUTION:</b> This indicates that the equipment may be damaged if procedures are not carried out in the proper manner.</p>
	<p><b>DANGER WARNING:</b> The MAGICFX® Stage Flame may only be operated by authorised adults.  The Stage Flame may only be operated if all parts are entire and in good working order and properly connected/installed.</p>

Operate the Stage Flame as follows:

1.



After you have readied the Stage Flame and set the DMX addresses properly, you are clear to operate the Stage Flame.

You previously set a “safety” channel for the Stage Flame so that the device should still be in safety mode. You now take it out of safety mode by setting the channel to between 40% and 60%.

The Stage Flame now counts down for three seconds while it checks the system and activates itself for use.

The LED lighting on the back of the Stage Flame will start blinking in turn.

2.



Press the flash button for the selected “fire” channel on the DMX controller. A flame should now be emitted from the Stage Flame.



Before you shoot flames, always check that there are no persons in the area near the Stage Flame. Ensure that you have a full view of the Stage Flame when it is flaming.

Consult the DMX controller manual for instructions on how to operate it properly.

**3.**

After you have used the Stage Flame, you must set it to safety mode again. You put the Stage Flame in safety mode by sliding shut the safety channel or setting it to a value outside the 40% to 60% range.



The Stage Flame cannot be used when it is in safety mode.

## 12. TURNING OFF

Turn off the Stage Flame as follows:

1.



Ensure that the DMX addresses are set to safety mode.

2.



Turn off the Stage Flame power button and disconnect the powerCON cable and DMX plugs.

3.



If a gas bottle was used then this must be shut off first before you disconnect the gas hose.

4.



Wait fifteen minutes until the Stage Flame is cooled off before you remove the aerosol can and pack up the Stage Flame.

## 13. TROUBLESHOOTING

- **Stage Flame still does not work after troubleshooting**

Always contact your dealer or the MAGIC FX technical department if you have any doubts or questions about the operation of or other issues related to the Stage Flame.

## 14. TECHNICAL SPECIFICATIONS

Dimensions and weight	Length:	360mm (14.2")
	Breadth:	310mm (12.2")
	Height:	210mm (8.3")
	Weight:	11.5 Kg (23.4lbs.)
Power	Input:	AC 230V~50-60Hz
	Consumption:	100W (idle)
	Fuse:	1A 250V 5x20mm
DMX	Input:	3 pin Neutrik XLR Male Socket
	Output:	3 pin Neutrik XLR Female Socket

## 15. MAINTENANCE

To prolong the life of the Stage Flame for as long as possible, you must regularly clean it and test that it is working properly.

Regardless of the reason, contact MAGIC FX if the Stage Flame does not work properly

	<p><b>DANGER WARNING:</b>  <b>Never replace parts yourself. Always consult MAGIC FX when needed.</b></p>
---	--

## 16. GUARANTEE

The MAGIC FX Stage Flame has a 3 year factory guarantee.

- The guarantee is annulled should the Stage Flame be used for purposes other than intended or for applications that are not listed in the manual.
- The guarantee is annulled should the device be used incorrectly or in a manner contrary to its instructions.
- The guarantee is annulled if the device is altered without the permission of its supplier.