

## MAGICFX® SHOT BASE DMX



PRODUCT CODE : MFX0350  
VERSION : 1.0  
DATE : 26.02.2013



## 1. CONGRATULATIONS!

You have bought a great new product from MAGICFX®.

MAGIC FX is a Dutch manufacturer of professional special effects machines and equipment. We have been experts in special effects since our establishment in 1995. All our products are made under the brand name MAGICFX® which by now has acquired a great reputation on account of its quality and reliability. All products are made in accordance with the European Machinery Directive. MAGIC FX manages the entire production process in-house, from the design stages and prototyping to production. In short, we cover everything from concept to ready-to-use product.



Moreover, MAGIC FX is Europe's largest supplier of high-quality and fireproof confetti products and streamers. Thanks to our very large stock levels, we can deliver quickly and at low prices.

MAGICFX® is used by special effects professionals all over the world and our products are distributed through a dealer network which covers more than 80 countries.

Congratulations and enjoy your purchase!

# MAGIC:CFX®

## 2. CE MARKING

	<p><b>PLEASE NOTE:</b> We presume that you, your employees and others who use or come into contact with the machine are familiar with how the machine must be dealt with. This includes the correct use, maintenance and repair of the machine as described in this user manual. This also means that the employees are familiar with the use of machines through training or experience.</p>
	<p><b>DANGER WARNING:</b> Only use the Shot Base DMX in accordance with the regulations and instructions in this manual. Consult MAGIC FX in case of doubt.</p>

Disclaimers:

MAGIC FX B.V. excludes liability for unsafe situations, accidents and damage that are the result of:

- Disregard for the warnings or regulations as set out on the Shot Base DMX or in this documentation.
- Use for other purposes or under other circumstances than those set out in this documentation.
- Alterations to the Shot Base DMX. This also includes the use of replacement parts other than the original ones.
- Insufficient maintenance.
- Unauthorised removal of safety caps and/or safeguards.
- Incompetent operation of the machine.

MAGIC FX B.V. is not liable for any consequential loss in the event of a Shot Base DMX breakdown.

© Copyright 2012

All rights are reserved. Nothing from this manual may be duplicated, or kept in an automated data file, or made public, or in any form or manner, whether electronically, mechanically, by photocopying, by incorporation, or in any other manner duplicated without the permission of MAGIC FX B.V.

MAGIC FX at all times retains the right to make alterations without the direct knowledge of the client. The contents of this user manual can also be changed.

Please contact the technical department of your supplier for extra information with regard to, for example, maintenance and repair. This user manual has been drawn up with the utmost care. MAGIC FX cannot be held responsible for any mistakes made in this publication or for any consequences thereof.

### 3. DECLARATION OF CONFORMITY

---

**DECLARATION OF CONFORMITY**  
(according to Annex II.1.A of the Machinery Directive)



Concerning the Machinery Directive.  
We; MAGIC FX B.V.  
Schouwrooij 27  
5281 RE Boxtel  
The Netherlands

State under personal responsibility:  
We are the manufacturer of the product:

**MF0350 - MAGICFX® Shot Base DMX**

to which this statement relates and which is in accordance with the provisions of the following Directive(s):

- Machinery Directive 2006/42/EC
- Low Voltage Directive 2006/95/EC
- EMC Directive 2004/108/EG

The following harmonising standards have been applied:

- NEN-EN-ISO 12100
- NEN-EN-ISO 60204-1

Place : Boxtel  
Date : 15-10-2012

Name: MAGIC FX

A handwritten signature in black ink, appearing to be 'B. Veroude', is written over a horizontal line. The signature is stylized and includes a large circular flourish on the left side.

Director: B. Veroude





## 4. FOREWORD

This manual describes the MAGICFX® Shot Base DMX. The information in this manual is important for the proper and safe functioning of the Shot Base DMX. If you are not familiar with the installation, operation, preventative maintenance etc. of the Shot Base DMX then please read this user manual carefully from beginning to end. MAGIC FX also insists that all new users (operators, installers, maintenance workers and cleaners) receive a training course in which this user manual can serve as a starting point.

MAGIC FX advises that the original of this user manual, including appendices, is kept at a safe and central place. It is best that another original or copy is kept close to the Shot Base DMX at the workplace.

If you are familiar with these matters, then you can use this manual as a work of reference.

The following standard markings are used in this manual for drawing attention to certain subjects or actions.

	<p><b>TIP:</b> Gives you suggestions and advice regarding easier or more convenient ways to carry out certain tasks.</p>
	<p><b>PLEASE NOTE:</b> A comment with additional information: alerts you to certain problems.</p>
	<p><b>CAUTION:</b> The machine can be damaged if you do not follow the procedures carefully.</p>
	<p><b>DANGER WARNING:</b> You can get (seriously) hurt if you do not carefully carry out the procedures.</p>

# CONTENTS

1.	CONGRATULATIONS! .....	1
2.	CE MARKING.....	2
3.	DECLARATION OF CONFORMITY.....	3
4.	FOREWORD .....	4
5.	INTRODUCTION .....	6
5.1	DESCRIPTION AND APPLICATION OF THE SHOT BASE DMX .....	6
5.2	NECESSARY ACCESSORIES.....	6
5.3	CANNONS.....	6
6.	SAFETY .....	8
6.1	INTRODUCTION .....	8
6.2	GENERAL SAFETY RULES.....	8
6.3	WARNINGS.....	9
7.	PARTS .....	10
8.	ACCESSORIES.....	11
9.	PREPARATIONS .....	11
10.	INSTALLATION .....	12
11.	USAGE .....	16
12.	SWITCHING OFF .....	18
13.	TROUBLESHOOTING .....	19
14.	TECHNICAL SPECIFICATIONS .....	20
15.	MAINTENANCE .....	20
16.	GUARANTEE .....	20

## 5. INTRODUCTION

### 5.1 DESCRIPTION AND APPLICATION OF THE SHOT BASE DMX

The Shot Base DMX is a confetti shooting system which has been specially developed to easily shoot electric cannons from a podium or truss.

The Shot Base DMX can be used with electric confetti cannons as well as with electric streamer cannons.

The Shot Base DMX runs on 230V~50/60Hz and is controlled by DMX-512.

As the Shot Base DMX can be used in various ways, it is important to read this user manual carefully from beginning to end before you start operating the machine.

Any use other than that described above excludes your supplier from any liability.

### 5.2 NECESSARY ACCESSORIES

The following parts belong to the Shot Base DMX:

		
Manual	MFX0308 – Power cable	Electric Cannons

Table 5.1

### 5.3 CANNONS

The Shot Base DMX offers the possibility to work with approved electric confetti and streamer cannons. The Shot Base DMX is not suitable for cannons other than those described below.

		
40cm Electric cannons	80cm Electric cannons	Andere confetti cannons

Table 5.2

The following types of electric cannons are possible:







TYPE CANNON	CONTENT	CANNON LENGTH	OUTPUT
	<p><b>CONFETTI (150g)</b></p>	<p><b>40CM</b></p>	<p><b>5M</b></p>
	<p><b>STREAMERS (150g)</b></p>	<p><b>40CM</b></p>	<p><b>12M</b></p>
	<p><b>CONFETTI (300g)</b></p>	<p><b>80CM</b></p>	<p><b>12M</b></p>
	<p><b>STREAMERS (300g)</b></p>	<p><b>80CM</b></p>	<p><b>20M</b></p>

Table 5.3

All pre-filled cannons are for one-off use only.

	<p><b>CAUTION:</b> Metallic products are heavier and will therefore have a larger output.</p>
	<p><b>CAUTION:</b> The electric cannons contain pressure containers which fire off the confetti/streamers under a lot of pressure. Therefore always make sure there is a free shooting range.</p>



---

## 6. SAFETY

### 6.1 INTRODUCTION

The MAGICFX<sup>®</sup> Shot Base DMX is a device for electronically shooting electric cannons from a distance. These electric cannons have been pre-filled with confetti or streamers and are available in two sizes, 40cm and 80cm. The length of the electric cannons not only determines the content but also the output of the contents to be expelled.

The Shot Base DMX must be placed and used in surroundings that preferably:

- Have a reasonably stable temperature of between 0 and 30°C.
- Have a relative humidity degree of no more than 75%.
- Are reasonably free of dust, corrosive gases and high concentrations of organic vapours.

The Shot Base DMX has been designed and constructed in such a manner that it can be used safely. This applies to the use, the circumstances and the regulations as described in this documentation. Reading this documentation and following the instructions are therefore necessary for everyone who is authorised to work with the Shot Base DMX.

### 6.2 GENERAL SAFETY RULES

- Only use the Shot Base DMX if there are no people, animals or other objects in the direction of the electric cannon within the output distance. The shooting direction is the direction in which the electric cannon in the Shot Base DMX is pointed. The output distance depends on the content and length of the electric cannons.
- Make sure that children, unauthorised people and animals do not obtain access to the Shot Base DMX!
- Do not take hold of the Shot Base DMX while it is working or is switched on. Also, when the Shot Base DMX is not working, the electric cannon may still be filled.
- Safety devices may not be removed or disabled.
- All required safety devices must be in good condition and function properly.
- Ensure sufficient lighting of the surroundings.
- Keep the workplace clean.
- Only authorised persons may carry out work with the Shot Base DMX.

### 6.3 WARNINGS

Warning texts have been attached to the Shot Base DMX. With regard to these the following rules apply:

- These texts may not be removed or damaged. The operator must regularly check if this is the case.
- The operator must ensure that the texts are and remain clearly visible and legible.

	<p><b>DANGER WARNING:</b>  <b>One must replace texts or signs if these are absent, damaged or illegible.</b></p>
---	--

Sign and explanation	Photo
 <p>PIC 616 Follow the instructions</p>	
<p>The operator must be told that he/she may only operate the Shot Base DMX after reading the user manual.</p> <p>A warning is given for this by means of the command sign of PIC 616. This sign should be attached to the type sign. See also the photo.</p>	

Sign and explanation	Photo
 <p>PIC 307 Danger: high voltage</p>	
<p>A warning must be given about the machine's high voltage by using the caution sign PIC 307. This sign must be attached to the Shot Base DMX. See also the added photo.</p>	

## 7. PARTS

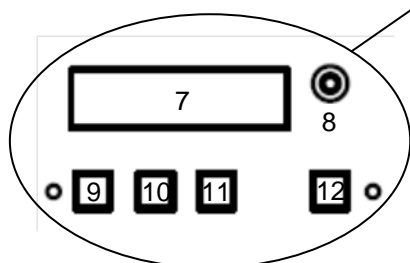
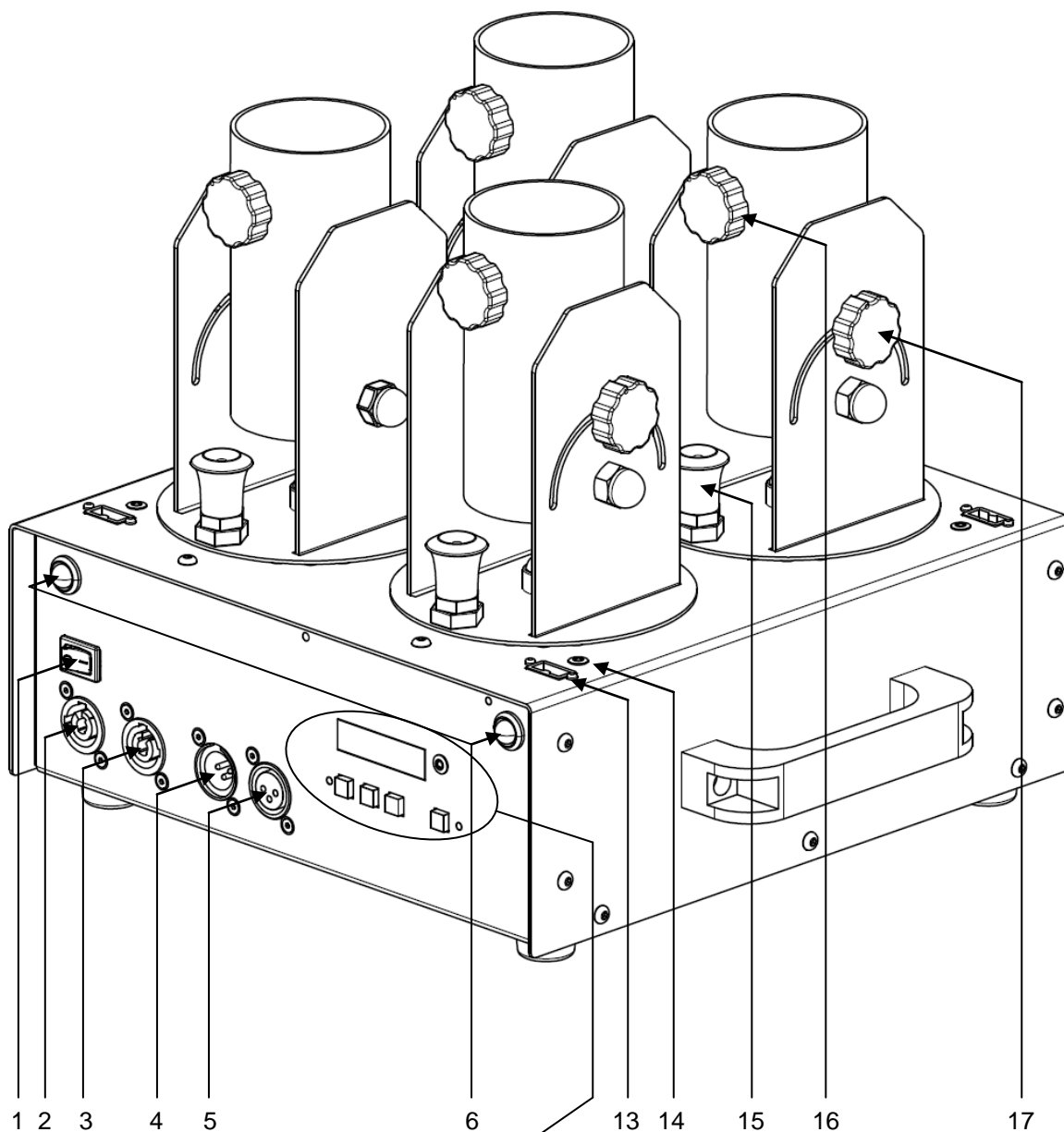

- |                 |                       |
|-----------------|-----------------------|
| 1. Power switch | 10. UP button         |
| 2. Power input  | 11. DOWN button       |
| 3. Power output | 12. RESET button      |
| 4. DMX input    | 13. Cannon connection |
| 5. DMX output   | 14. Indicator LED     |
| 6. Warning LEDs | 15. Turning lock      |
| 7. Display      | 16. Cannon screw nut  |
| 8. DMX LED      | 17. Right screw nut   |
| 9. MENU button  |                       |

## 8. ACCESSORIES

		
MFX0309 – Power link cable	MFX0308 – Power cable	MFX3103 – Twenty clamp M10

Table 8.1

You can order these parts and accessories from:



MAGIC FX B.V.  
Schouwrooij 27  
NL-5281 RE BOXTEL  
The Netherlands  
T. +31(0)411 63 50 13  
F. +31(0)411 63 50 12  
W. <http://www.magicfx.eu>  
E. [info@magicfx.eu](mailto:info@magicfx.eu)



## 9. PREPARATIONS

Unpack the Shot Base DMX. Dispose of the packaging material without harming the environment. Inspect the machine for any damage. If damage is noticed this must be reported to MAGIC FX.

## 10. INSTALLATION

	<p><b>CAUTION:</b> The machine can be damaged if you do not follow the procedures carefully.</p>
	<p><b>DANGER WARNING:</b> The MAGICFX® Shot Base DMX may only be installed by adults and authorised persons.</p>

Prepare the Shot Base DMX for use as follows:

**1a**



If you want to use the Shot Base DMX in a standing position, then place the Shot Base DMX on an even, solid and stable surface.

Then continue to step 2.

**1b**



If you want to use the Shot Base DMX mounted in a truss system, then attach 2 certified truss clamps (MFX3104) to the underside of the Shot Base DMX.

Then place the Shot Base DMX on the required place in the truss system and firmly turn the clamp.

Then continue to step 2.

2.



Check if the on/off switch is in the 'off' position and then connect the electricity cable. The Shot Base DMX runs on 230V~50/60Hz. You will need a powerCON plug to be able to provide the Shot Base DMX with electricity. The Shot Base DMX is also equipped with a powerCON output. By connecting a powerCON loop cable (MFX0309) to this you can connect several machines to the same electricity source.

3.



Connect a 3-pin DMX cable to the Shot Base DMX.



No more than 1200m distance is permitted between the controller and the receiver. Furthermore, no more than 32 DMX receivers may be connected to 1 DMX sender. Maintain these standards for a faultless operation. **If required you can connect several machine to each other by using 3-pin DMX cables**

4.



Connect the other end of the DMX cable (male plug) to a professional DMX controller.



Make sure that you always place the controller is such a way that the operator has full sight of all the connected machines.



Consult the manual of your DMX controller for instructions and safe use.

5.



To switch on the machine, turn the switch on the Shot Base DMX to the 'on' position.

The display will show the screen on the left for one 1 second.

6.

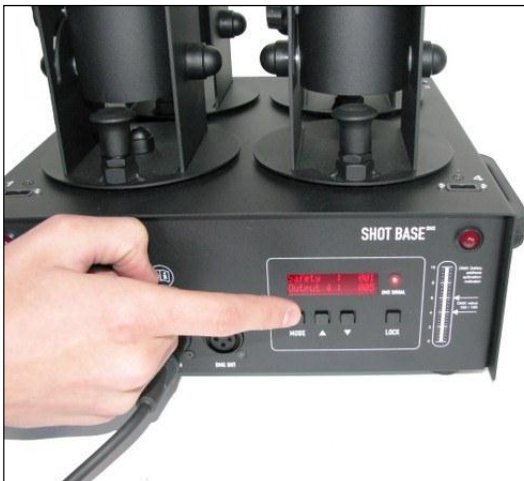

Before you start to load the Shot Base DMX with the cannons you must install the Shot Base DMX correctly.



During installation, make sure that you use free channels on the DMX controller and that these channels are in the safe mode. The safe mode means that during the installation of the Shot Base DMX the 0-values of a channel are set. Consult the manual of the DMX controller for the set-up.

7.

Set addresses  
by sequence

-Of-

Set addresses  
individually

Press the 'MODE' button to start the Shot Base DMX set-up.

The Shot Base DMX now gives you two set-up choices.

#### Set addresses by sequence

You only set the Safety address and the first output address through which the other 3 output addresses are automatically set in numerical order.

#### Set addresses individually

You set all 5 addresses separately.

Change to the required mode by pressing the ▲ or ▼ button. Then press the MODE button to confirm your choice.

8.

Safety : 001  
Output 1 : 002

The display will now show the screen pictured on the left.

You will see the address behind Safety flash on and off: this is the address for releasing the machine.

Change to the required address by pressing on the ▲ or ▼ button. Then press the MODE button to confirm your choice.



When using several machines it is recommended to use the same 'Safety' channel for each Shot Base DMX.

If you want to restore the addresses to standard values then press on the LOCK button for each address. The address will then return to the standard value.

# 9.

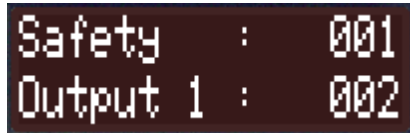

Safety : 001  
Output 1 : 002

Now the address behind Output 1 will start flashing on and off. You can set this in the same way as the Safety address.



If at the first setting you have opted for **Set addresses by sequence** and you have completed the stage, then you are finished with the step-up.

If you have opted for **Set addresses individually** then you repeat the action until all addresses have been set.



It is not possible to set one of the output addresses at the same address as the Safety address. If you use the **Set addresses by sequence** option make sure that you always chose an output address that is 1 higher or 4 lower than the set safety address.

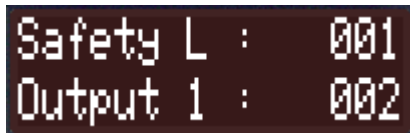

Safety L : 001  
Output 1 : 002

It is possible to switch off the buttons for safety reasons.



Keep the Lock button pressed down for 5 seconds to switch the buttons on or off.



The machine is locked when an L appears in the screen as pictured on the left.



## 11. USAGE

	<p><b>TIP:</b> Gives you suggestions and advice regarding easier or more convenient ways to carry out certain tasks.</p>
	<p><b>CAUTION:</b> The machine can be damaged, if you do not follow these procedures carefully.</p>
	<p><b>DANGER WARNING:</b> The MAGICFX® Shot Base DMX may only be installed by adults and authorised persons.</p> <p>The Shot Base DMX may only be operated if all parts are completely and correctly installed/connected.</p>

For using the Shot Base DMX take the following steps:

1.



Load the Shot Base DMX with the cannons you have selected. Place the cannons in the holders intended for this.

2.



Turn the buttons above the holders until they are pressed tightly against the cannons.

3.



Then connect the connectors of the cannons to the accompanying output.



If the cable is too short then use the cable extension provided.  
If you cannot insert the connector properly in the output then squeeze the front piece of the connector tightly so that it will properly go into the output.

4.



To get the Shot Base DMX out of the safe mode, the 'safety' channel on the Shot Base DMX must be set between 40% and 60%.

The LED light on the back of the Shot Base DMX now starts to flash on and off.

Press the flash buttons of the set output channels on the DMX controller.  
The cannons connected to the Shot Base DMX now go off if the right output has been chosen.



Before you start firing the canons always check to make sure that nobody is situated within the output direction of the Shot Base DMX. Also always make sure that there is a good view on the Shot Base DMX during the special effect.



Consult the manual of the DMX controller for correct use.



After using the Shot Base DMX the machine must be set in the safe mode again.

Put the Shot Base DMX in the safe mode by closing the 'Safety' channel or by giving it a value outside the 40-60% range.



The Shot Base DMX cannot be used when it is in the safe mode.

## 12. SWITCHING OFF

To switch off the Shot Base DMX, take the following steps:

1.



Make sure that the Shot Base DMX is in the safe mode.

2.



Switch off the Shot Base DMX by pressing the electricity switch in the 'off' position.

3.



Remove the powerCON cable and DMX cables.

4.



Remove all cannons from the Shot Base DMX.

## 13. TROUBLESHOOTING

- **The machine does not turn on.**

Check if the powerCON cable is properly connected. If so, check to see if the switch is in the 'on' (I) position.

- **The machine does not respond to the DMX controller.**

First check if all cabling is properly connected to the right connecting points.

Then check if the DMX control is switched on and if this is actually sending a signal by, for example, connecting another DMX machine.

If this machine does respond then check if the addresses are properly set in the machine. Instructions on how to do this can be found on pages 13 and 14 of this manual.

- **It is impossible to change the settings.**

The machine is probably in the LOCK position. On the display there is an L showing behind 'Safety'.

This can be resolved by pressing down the LOCK button for 5 seconds.

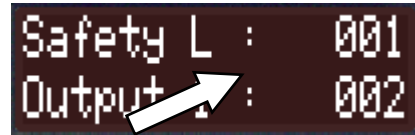

- **The cable of the cannon is too short for the connection.**

Use the extension piece provided to make the cable fit.

- **A cannon is not going off.**

Check to see if the connector of the cannon is properly connected. If so, exchange the cannon for another and see if this one does go off.

- **The Shot Base DMX is still malfunctioning after troubleshooting**

Always contact your dealer or the technical service of MAGIC FX first in case of uncertainties, questions about the Shot Base DMX works or other issues with regard to the Shot Base DMX.

## 14. TECHNICAL SPECIFICATIONS

Measurements and weight	Length:	310mm (12.2")
	Width:	380mm (14.96")
	Height:	295mm (11.61")
	Weight:	9.75 Kg (21.5lbs.)
Power	Input:	AC 230V~50-60Hz
	Output:	AC 12V~50-60Hz
	Usage:	400W
	Fuse:	Short circuit protection
DMX	Input:	3-pin Neutrik XLR Male Socket
	Output:	3-pin Neutrik XLR Female Socket

Design and product specifications can be changed without prior notification.

## 15. MAINTENANCE

To achieve the maximum service life of the Shot Base DMX you must regularly clean the Shot Base DMX and test if it is working correctly.

Should the Shot Base DMX not work for some reason then please contact MAGIC FX.



**DANGER WARNING:**  
Do not replace parts yourself; always consult MAGIC FX if necessary.

## 16. GUARANTEE

A manufacturer's guarantee of 3 years applies to the MAGIC FX Shot Base DMX.

- The guarantee expires if the Shot Base DMX is used for improper purposes and for applications which are not stated in this manual.
- The guarantee also expires if the machine is used incorrectly or in violation of the regulations.
- The guarantee expires if the machine is altered without permission from the supplier.