

MAGICFX[®] POWER DROP



PRODUCT CODE : MFX1501
VERSION : 1.0
DATE : 23.04.2014



1. FOREWORD

Congratulations! You have bought a great new product from MAGICFX®.

The MAGIC FX Power Drop is a robust and simple device designed for safely dropping backdrops (cloths) from a truss system. It is simple operated by powering the device to drop the backdrop. The Power Drop is capable of dropping up to 20 Kg when loaded perpendicular to. The Power Drop is also equipped with a blue indication LED to test the Power Drop.

MAGIC FX is a Dutch manufacturer of professional special effects machines and equipment. We have been experts in special effects since our establishment in 1995. All our products are made under the brand name MAGICFX® which by now has acquired a great reputation on account of its quality and reliability. All products are made in accordance with the European Machinery Directive. MAGIC FX manages the entire production process in-house, from the design stages and prototyping to production. In short, we cover everything from concept to ready-to-use products.

Moreover, MAGIC FX is Europe's largest supplier of high-quality and fireproof confetti products and streamers. Thanks to our very large stock levels, we can deliver quickly and at low prices.

MAGICFX® is used by special effects professionals all over the world and our products are distributed through a dealer network which covers more than 90 countries.





Congratulations and enjoy your purchase!

This manual describes the MAGICFX® Power Drop. The information in this manual is important for the proper and safe functioning of the Power Drop. If you are not familiar with the installation, operation, preventative maintenance etc. of the Power Drop then please read this user manual carefully from beginning to end. MAGIC FX also insists that all new users (operators, installers, maintenance workers and cleaners) receive a training course in which this user manual can serve as a starting point.

MAGIC FX advises that the original of this user manual, including appendices, is kept at a safe and central place. It is best that another original or copy is kept close to the Power Drop at the workplace.

If you are familiar with these matters, then you can use this manual as a work of reference.

The following standard markings are used in this manual for drawing attention to certain subjects or actions.

	<p>TIP: Gives you suggestions and advice regarding easier or more convenient ways to carry out certain tasks.</p>
	<p>PLEASE NOTE: A comment with additional information: alerts you to certain problems.</p>
	<p>CAUTION: The machine can be damaged if you do not follow the procedures carefully.</p>
	<p>DANGER WARNING: You can get (seriously) hurt if you do not carefully carry out the procedures.</p>

CONTENTS

1.	FOREWORD	1
2.	INTRODUCTION	3
2.1	DESCRIPTION AND APPLICATION OF THE POWER DROP	3
2.2	NECESSARY ACCESSORIES.....	3
3.	SAFETY	4
3.1	INTRODUCTION	4
3.2	GENERAL SAFETY RULES.....	4
3.3	WARNINGS.....	4
4.	PARTS	6
5.	ACCESSORIES.....	7
6.	PREPARATIONS	7
7.	INSTALLATION	8
8.	USAGE.....	11
9.	SWITCHING OFF	12
10.	CE MARKING.....	13
11.	DECLARATION OF CONFORMITY.....	14
12.	TROUBLESHOOTING	15
13.	TECHNICAL SPECIFICATIONS	15
14.	MAINTENANCE	15
15.	GUARANTEE	15

2. INTRODUCTION

2.1 DESCRIPTION AND APPLICATION OF THE POWER DROP

The Power Drop is a machine which has been specially developed for the controlled dropping of backdrops (cloths) from a truss system. Through the working of the mechanism the Power Drop can also be used to let go of certain objects such as balloons or rolled up banners.

The Power Drop runs on 230V~50/60Hz and is controlled by means of a standard 230V impulse.

As the Power Drop can be set in various ways it is important to read this user manual carefully from beginning to end before you start operating it.

The CO2 Dominator has been designed and constructed in such a manner that it can be used safely. This applies to the application, the circumstances and the regulations as described in this documentation. Reading this documentation and the following instructions are therefore necessary for everyone who is authorised to work with the CO2 Dominator.

Any use other than that described above excludes your supplier from any liability.

2.2 NECESSARY ACCESSORIES

The following parts belong to the Power Drop:



3. SAFETY

3.1 INTRODUCTION

The Power Drop has been designed and constructed in such a manner that it can be used safely. This applies to the use, the circumstances and the regulations as described in this documentation. Reading this documentation and following the instructions are therefore necessary for everyone who is authorised to work with the Power Drop.

The Power Drop must be placed and used in surroundings that preferably:

- Have a reasonably stable temperature of between 0 and 30°C.
- Have a relative humidity degree of no more than 75%.
- Are reasonably free of dust, corrosive gases and high concentrations of organic vapours.
- Are not situated in the vicinity of a source of vibration.

3.2 GENERAL SAFETY RULES



- Ensure that children, unauthorised persons and animals cannot obtain access to the Power Drop!
- Safety devices may not be removed or disabled.
- All required safety devices must be in good condition and function properly.
- Ensure sufficient lighting of the surroundings.
- Keep the workplace clean.
- Only authorised persons may carry out work with the Power Drop.

3.3 WARNINGS

Warning texts have been attached to the Power Drop. With regard to these the following rules apply:

- These texts may not be removed or damaged. The operator must regularly check if this is the case.
- The operator must ensure that the texts are and remain clearly visible and legible.

	<p>DANGER WARNING: One must replace texts or signs if these are absent, damaged or illegible.</p>
---	--

Sign and explanation	Photo
 <p>PIC 616 Follow the instructions</p>	
<p>The operator must be told that he/she may only operate the Power Drop after reading the user manual.</p> <p>A warning is given for this by means of the command sign of PIC 616. This sign should be attached to the type sign. See also the photo.</p>	

Sign and explanation	Photo
<div data-bbox="395 241 592 412" data-label="Image"></div> <p data-bbox="316 461 671 495">PIC 307 Danger: high voltage</p> <p data-bbox="209 521 770 645">A warning must be given about the machine's high voltage by using the caution sign PIC 307. This sign must be attached to the Power Drop. See also the added photo.</p>	<div data-bbox="810 331 1396 645" data-label="Image"></div>

4. PARTS

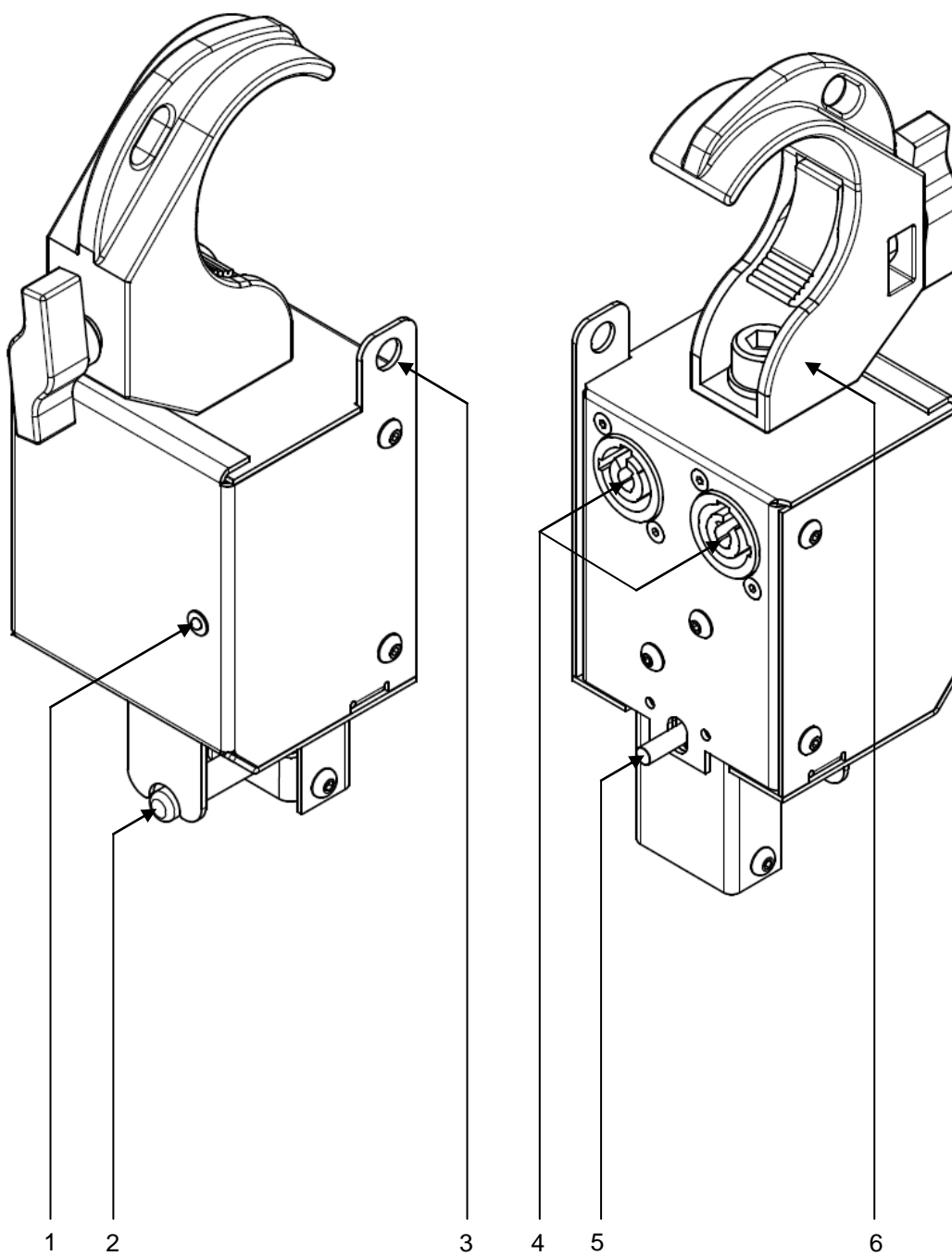

1. LED indicator
2. Drop hook
3. Safety eye
4. Power in & out
5. Reset pin
6. Truss clamp

5. ACCESSORIES



Table 5.1

You can order these parts and accessories from:



MAGIC FX B.V.
Schouwrooij 27
NL-5281 RE BOXTEL
The Netherlands
T. +31(0)411 63 50 13
F. +31(0)411 63 50 12
W. <http://www.magicfx.eu>
E. info@magicfx.eu



6. PREPARATIONS

Unpack the Power Drop. Dispose of the packaging material without harming the environment. Inspect the machine for any damage. If damage is noticed this must be reported to MAGIC FX.

7. INSTALLATION

	<p>CAUTION: The machine can be damaged if you do not follow the procedures carefully.</p>
	<p>DANGER WARNING: The MAGICFX® Power Drop may only be installed by adults and authorised persons.</p>

Prepare the Power Drop for use as follows:

1.



Attach the Power Drop in a firm truss construction.

Mount the Power Drop vertically under the truss construction.

2.

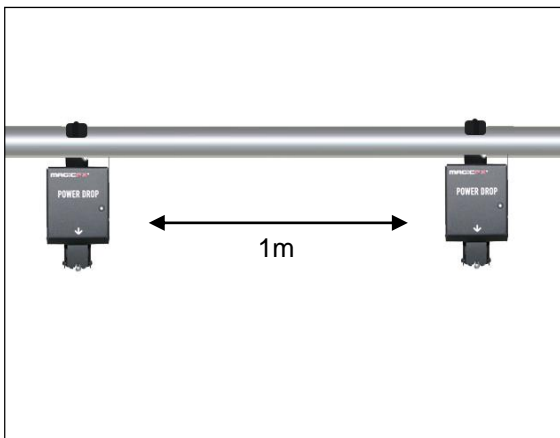

Take the width of your cloth or object that has to be dropped and determine where the first and last Power Drop have to be suspended.

Place the other Power Drops between the first and last Power Drop with a spacing measurement of about one metre. This prevents sagging and provides enough stability.

3.



Then connect the first Power Drop with a schuko plug to the powerCON cable.

4.



For connecting the next Power Drop use a powerCON-out cable to powerCON-in cable.



Never connect more than 25 Power Drops consecutively to a standard 16A free group.

5.



Connect the Power Drops to a 230v electricity source to check if all Power Drops have been connected properly. When everything is connected properly the blue LED indicators will light up on the Power Drops.

6.



Disconnect the Power Drops again from the electricity source and now connect a switching device between this electricity source.



Make sure that this switching device is suitable for switching the electricity.

7.

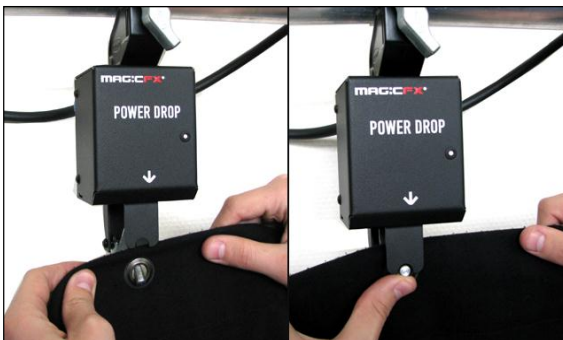

Now hang up the cloth (backdrop).

You do this by sliding the rings in the cloth over the drop pins and then locking the pins by pushing them upwards.

Once you have hung up the cloth your Power Drop system is ready for use.

8.



If you want to use a cloth, banner or flag, which is not provided with rings, then use the special 'curtain clamps'.

Just attach the curtain clamp to the cloth by clamping the cloth in between and by sliding the opening of the curtain clamp over the drop pins of the Power Drop.

9.



Then push the opening of the curtain clamp over the drop pin of the Power Drop and click this to a closed position as described in step 7.



If you want to prematurely release the cloth or rehang it, then use the unlocking pin at the reverse side of the Power Drop.



By pushing this pin upwards the drop mechanism will unlock and let go of the cloth.



Always use an approved safety cable when attaching a Power Drop so as to secure the Power Drop to the truss or scaff pipe.



There is an eye on the side of the Power Drop to which the safety cable can be attached.

8. USAGE

	<p>TIP: Gives you suggestions and advice regarding easier or more convenient ways to carry out certain tasks.</p>
	<p>CAUTION: The machine can be damaged, if you do not follow these procedures carefully.</p>
	<p>DANGER WARNING: The MAGICFX® Power Drop may only be installed by adults and authorised persons.</p> <p>The Power Drop may only be operated if all parts are completely and correctly installed/connected.</p>

For using the Power Drop take the following steps:

1.

	<p> When the Power Drop receives an electric current it will let go of the cloth.</p> <p>Push the switch to turn on the electricity and to let the cloth drop.</p> <p> Make sure that you turn on the electricity long enough (at least 1 sec.)</p>
--	---



	<p>The Power Drop can be operated by means of DMX. To this end use a DMX FX Switchpack.</p> <p> Make sure that you always have the Power Drop within your sight.</p>
---	---

9. SWITCHING OFF

To switch off the Power Drop, take the following steps:

1.



Disconnect the powerCON cables from the Power Drop.

2.





Then loosen the truss clamp to take the Power Drop from the truss.

3.



Then put the Power Drops neatly in their flight case to prevent them from being damaged during transportation.

10. CE MARKING

	<p>PLEASE NOTE: We presume that you, your employees and others who use or come into contact with the machine are familiar with how the machine must be dealt with. This includes the correct use, maintenance and repair of the machine as described in this user manual. This also means that the employees are familiar with the use of machines through training or experience.</p>
	<p>DANGER WARNING: Only use the Power Drop in accordance with the regulations and instructions in this manual. Consult MAGIC FX in case of doubt.</p>

Disclaimers:

MAGIC FX B.V. excludes liability for unsafe situations, accidents and damage that are the result of:

- Disregard for the warnings or regulations as set out on the Power Drop or in this documentation.
- Use for other purposes or under other circumstances than those set out in this documentation.
- Alterations to the Power Drop. This also includes the use of replacement parts other than the original ones.
- Insufficient maintenance.
- Unauthorised removal of safety caps and/or safeguards.
- Incompetent operation of the machine.

MAGIC FX B.V. is not liable for any consequential loss in the event of a Power Drop breakdown.

© Copyright 2012

All rights are reserved. Nothing from this manual may be duplicated, or kept in an automated data file, or made public, or in any form or manner, whether electronically, mechanically, by photocopying, by incorporation, or in any other manner duplicated without the permission of MAGIC FX B.V.

MAGIC FX at all times retains the right to make alterations without the direct knowledge of the client. The contents of this user manual can also be changed.

Please contact the technical department of your supplier for extra information with regard to, for example, maintenance and repair. This user manual has been drawn up with the utmost care. MAGIC FX cannot be held responsible for any mistakes made in this publication or for any consequences thereof.

11. DECLARATION OF CONFORMITY

DECLARATION OF CONFORMITY (according to Annex II.1.A of the Machinery Directive)



Concerning the Machinery Directive.
We; MAGIC FX B.V.
Schouwrooij 27
5281 RE Boxtel
The Netherlands

State under personal responsibility:
We are the manufacturer of the product:

MFX1501 - MAGICFX[®] Power Drop

to which this statement relates and which is in accordance with the provisions of the following Directive(s):

- Machinery Directive 2006/42/EC
- Low Voltage Directive 2006/95/EC
- EMC Directive 2004/108/EG

The following harmonising standards have been applied:

- NEN-EN-ISO 12100
- NEN-EN-IEC 60204-1

Place : Boxtel
Date : 15-10-2012

Name: MAGIC FX

A handwritten signature in black ink, appearing to be 'B. Veroude', written over a horizontal line. The signature is stylized and includes a large circular flourish on the left side.

Director: B. Veroude

12. TROUBLESHOOTING

- **The Power Drop does not drop the load when it is given power.**

Check if the LED lights up when the Power Drop is given power. If so, then check if the load is lighter than 20kg. If so, supply the Power Drop with power for a longer period.

- **The Power Drop is still malfunctioning after troubleshooting**

Always contact your dealer or the technical service of MAGIC FX first in case of uncertainties, questions about the Power Drop works or other issues with regard to the Power Drop.

13. TECHNICAL SPECIFICATIONS

Measurements and weight	Length:	135mm (5.3")
	Width:	76mm (3.0")
	Height:	74mm (2,9")
	Weight:	0.9Kg (2.0lbs.)
	Max. load:	20.0Kg (44.1lbs.)
Power	Input:	AC 230V~50-60Hz
	Output:	AC 230V~50-60Hz
	Usage:	100W

Design and product specifications can be changed without prior notification.

14. MAINTENANCE

To achieve the maximum service life of the Power Drop you must regularly clean the Power Drop and test if it is working correctly.

Should the Power Drop not work for some reason then please contact MAGIC FX.

	<p>DANGER WARNING: Do not replace parts yourself; always consult MAGIC FX if necessary.</p>
---	--

15. GUARANTEE

A manufacturer's guarantee of 3 years applies to the MAGIC FX Power Drop.

- The guarantee expires if the Power Drop is used for improper purposes and for applications which are not stated in this manual.
- The guarantee also expires if the machine is used incorrectly or in violation of the regulations.
- The guarantee expires if the machine is altered without permission from the supplier.